

# KOMATSU®

# WA320-8

Tier 4 Final Engine

## WHEEL LOADER

# WA320



Photos may include optional equipment.

### NET HORSEPOWER

165 HP @ 2100 rpm  
123 kW @ 2100 rpm

### OPERATING WEIGHT

34,128 – 34,987 lb  
15480 – 15870 kg

### BUCKET CAPACITY

3.0 – 4.2 yd<sup>3</sup>  
2.3 – 3.2 m<sup>3</sup>

# WALK-AROUND

WA320-8



Photos may include optional equipment.

## NET HORSEPOWER

165 HP @ 2100 rpm  
123 kW @ 2100 rpm

## OPERATING WEIGHT

34,128 – 34,987 lb  
15480 – 15870 kg

## BUCKET CAPACITY

3.0 – 4.2 yd<sup>3</sup>  
2.3 – 3.2 m<sup>3</sup>



## HIGH PRODUCTION WITH LOW FUEL CONSUMPTION

### Proven, Fourth Generation Hydrostatic Transmission:

- Quick Acceleration
- Dynamic Braking
- Variable Speed Traction Control
- Creeping Mode

**Komatsu SmartLoader Logic** helps reduce fuel consumption with no decrease in production.

A powerful **Komatsu SAA6D107E-3 engine** provides a net output of 123 kW **165 HP** with up to 3% improved fuel consumption. This engine is EPA Tier 4 Final emissions certified.

**Variable Geometry Turbocharger (VGT)** is hydraulically actuated to provide optimum air flow under all speed and load conditions. This Tier 4 Final version has improved performance.

**Komatsu Diesel Particulate Filter (KDPF) and Selective Catalytic Reduction (SCR) systems** reduce particulate matter and NOx while providing automatic regeneration that does not interfere with daily operation.

### Ample cooling capacity

- Auto-reversing fan is standard
- Wider core coolers

### Fluid neutral or better

Combined fuel and DEF consumption is equal to or less than the WA320-7 fuel consumption.

**Spacious cab** provides the operator with improved comfort and visibility.

### New high resolution monitor panel:

- Enhanced and intuitive on-board diagnostics
- Integrated with KOMTRAX Level 5
- Integrated with Komatsu Tier 4 Final technology

**Rearview monitoring system is standard.**

**New high capacity air suspension seat with heat is standard.**



### Energy saving guidance:

- Six operator guiding messages
- Enhanced ecology gauge

**Komatsu auto idle shutdown** helps reduce idle time and operating costs.

**Remote boom positioner** can set kickout.

**Versatile Parallel Z-bar (PZ) linkage** for parallel lift.

**Variable displacement piston pumps with Closed-Center Load Sensing System (CLSS)** help reduce fuel consumption.

**KOMTRAX®** equipped machines send location, SMR and operation maps to a secure website or smart phone via wireless technology. Machines also relay error codes, cautions, maintenance items, fuel & Diesel Exhaust Fluid (DEF) levels, and much more.

**Operator identification system** tracks machine operation for up to 100 operators.



# PERFORMANCE FEATURES

## KOMATSU NEW ENGINE TECHNOLOGIES

### New Tier 4 Final Engine

The Komatsu SAA6D107E-3 engine is EPA Tier 4 Final emissions certified, reduces fuel consumption, and provides exceptional performance. Based on Komatsu proprietary technologies developed over many years, this new diesel engine reduces nitrogen oxides (NOx) by more than 80% compared to Tier 4 interim levels.

### Technologies Applied to New Engine

#### Heavy-duty After Treatment System

This new system combines a Komatsu Diesel Particulate Filter (KDPF) and Selective Catalytic Reduction (SCR). The SCR NOx reduction system injects the precise amount of Diesel Exhaust Fluid (DEF) to break down NOx into non-toxic water vapor (H<sub>2</sub>O) and nitrogen gas (N<sub>2</sub>).

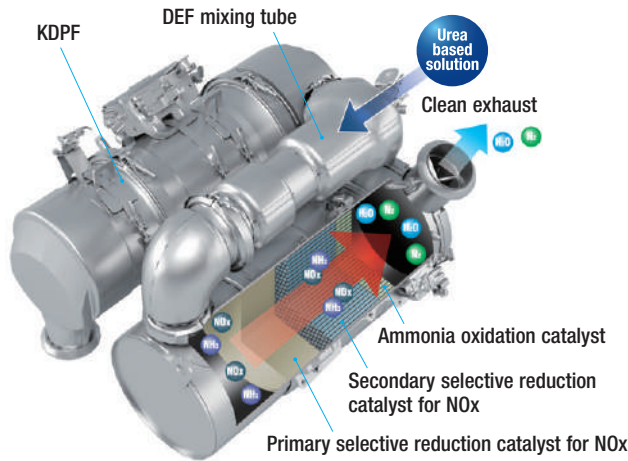

#### Heavy-duty Cooled Exhaust Gas Recirculation (EGR) System

The system recirculates a portion of exhaust gas into the air intake and lowers combustion temperatures, thereby reducing NOx emissions. EGR gas flow is lower for Tier 4 Final with the addition of SCR technology. The system dramatically reduces NOx, while helping cut fuel consumption below Tier 4 Interim levels.

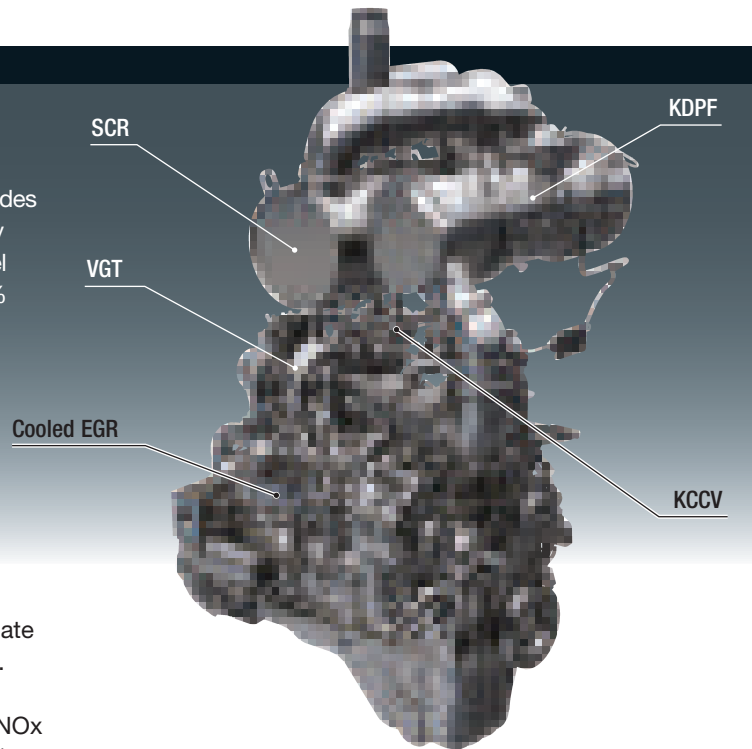
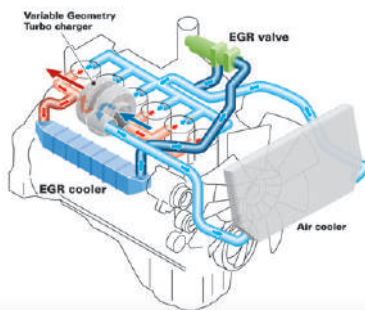

#### Advanced Electronic Control System

An improved electronic control system more effectively manages engine parameters such as airflow rate, EGR gas flow rate, fuel injection parameters, and after treatment function. The control system also provides enhanced diagnostics through the monitor panel. Additionally, managing information via KOMTRAX helps customers track required maintenance.

#### Variable Geometry Turbocharger (VGT) system

The VGT features proven Komatsu-designed hydraulic technology for robust and accurate control under all speed and load conditions for optimal engine performance. The VGT also provides precise exhaust temperature control for efficient KDPF regeneration. The Tier 4 Final version has a smaller impeller for improved performance.

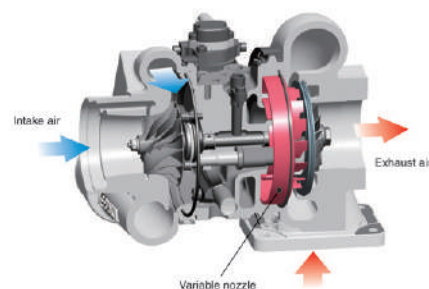

### Heavy-Duty High-Pressure Common Rail (HPCR) fuel injection system

The system is specifically designed to achieve the optimal injection of fuel for near-complete combustion, which helps reduce Particulate Matter (PM) emissions.

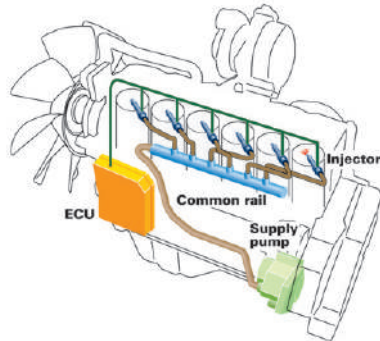

### Komatsu SmartLoader Logic

The WA320-8 features Komatsu SmartLoader Logic, which controls engine torque to match machine demands. For example, engine torque needs are higher for digging in V-shape loading, but lower when driving with an empty bucket. This system optimizes the engine torque for all applications to minimize fuel consumption. Komatsu SmartLoader Logic functions automatically and doesn't interfere with operation, saving fuel without decreasing production.

### Hydrostatic Transmission (HST)

The HST provides quick travel response and aggressive drive into the pile. Full auto-shifting eliminates any gear shifting and kick-down operation to allow the operator to concentrate on the digging and loading. The HST also acts as a dynamic brake to slow the loader. This dramatically extends the life of the wet disc brakes.

### Variable Traction Control System

The variable traction control system is designed to adjust the traction control for each working condition. S-mode reduces tire spin in slippery or snowy conditions. Auto-mode automatically optimizes the tractive effort for various working conditions. Max traction provides the full, 100%, tractive effort.

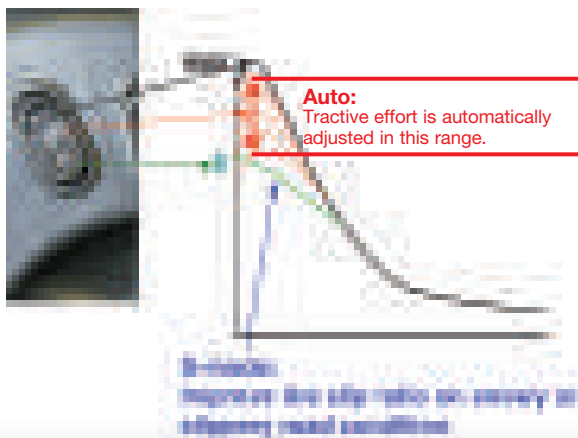

### Creep Mode

Creep mode limits the travel speed in 1st speed range, while still allowing for full hydraulic flow.



### Closed-Center Load Sensing System (CLSS)

The one-pump, two-motor system utilizes a Closed-Center Load Sensing System (CLSS) pump. This system minimizes hydraulic loss for better fuel economy by delivering only as much flow as the job requires.

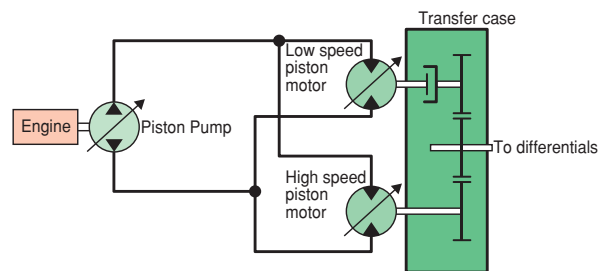

### Komatsu Auto Idle Shutdown

In order to reduce unwanted idle time, Komatsu offers Komatsu auto idle shutdown. This function will shut the engine off and apply the parking brake and hydraulic lock after a preset idle time limit. This time limit can be set by the operator or service technician and may range from three to 60 minutes. It can also be deactivated by the operator.



# OPERATOR ENVIRONMENT



## New Operator Seat

A new standard, heated, air-suspension seat provides enhanced support on rough roads and dampens machine vibrations, providing a more comfortable ride for the operator. The angle of the armrest is fully adjustable for optimum operator comfort. A secondary F-N-R switch is incorporated into the standard multi-function mono lever.



## Tiltable / Telescopic Steering Wheel

The operator can tilt and telescope the steering wheel to allow maximum comfort and control. The two-spoke steering wheel allows maximum visibility of the monitor panel and the forward work environment.



## Low Noise Design

Operator's ear noise level: 68 dB(A)  
Dynamic noise level (outside): 105 dB(A)

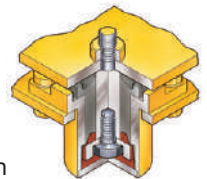

The large ROPS/FOPS cab is mounted with Komatsu's unique viscous mounts. The low-noise engine, hydraulically-driven fan, and hydraulic pumps are mounted with rubber cushions, and the cab sealing is improved to provide a quiet, low-vibration, comfortable operating environment.

## Increased Cab Storage Area

The WA320-8 cab features a storage box on each side of the cab to allow the operator to store items such as a beverage or lunch.







**Standard Rear View Monitoring System**

The dedicated full-color monitor on the right side of the cab provides the operator with a rear view from the machine. This monitor can be always on or only on when the loader shifts into reverse. Guidelines provide the operator with visual cues for the width of the loader.



**Engine Shutdown Secondary Switch**

The engine stop switch enables machine shutdown when accessing the key switch is not possible.

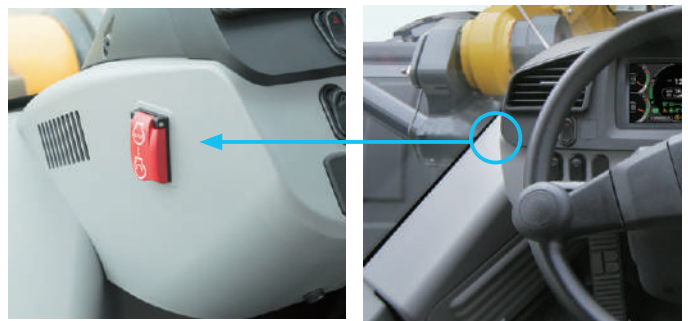

**Auxiliary Input (MP3 Jack) 12 V Outlets**

An Aux input for audio devices is standard as well as two 12 volt outlets. These are all located on the rear wall of the cab.

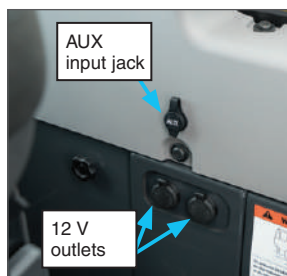

# WORKING ENVIRONMENT



## Easy Entry and Exit

The WA320-8 has an inclined ladder with wide steps and well-placed hand holds to ease entry and exit from the cab. The door latch can be reached from ground level to ease opening and closing the door.

## Electronically Controlled Suspension System

The standard Electronically Controlled Suspension System or ride control system uses an accumulator, which absorbs some of the shock in the boom arm, giving the operator a much smoother ride. This reduces operator fatigue and reduces material spillage during load and carry operations. Ride control is speed sensitive and the activation speed can be adjusted in the monitor panel.

## Multi-Function Mono Lever

The multi-function mono lever with EPC control for 3rd spool is standard. It includes a forward-neutral-reverse switch for quick and easy travel. Third spool attachments can be set to continual or proportional control via the monitor panel allowing the operator to control the boom, bucket and attachment all with a single lever.



## Remote Boom Positioner

The operator can set the upper boom limit from the cab.

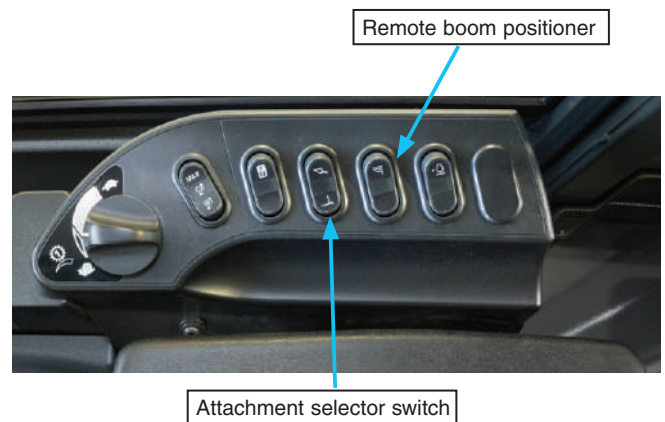

## Attachment Selector Switch

Coupler equipped machines which use buckets and forks require a different flat level setting when switching between attachments. The attachment selector switch found in coupler equipped machines tells the loader which flat level to use.



# INFORMATION & COMMUNICATION TECHNOLOGY

## New High Resolution LCD Monitor Panel

The new 7" color LCD monitor panel displays operational information, ecology guidance and maintenance records. Information such as traction mode, coolant temp, oil and fuel levels are easy to read to keep the operator informed of the machine's settings and conditions.

### Machine monitor

- |                           |                                    |
|---------------------------|------------------------------------|
| 1 LCD unit                | 8 Engine coolant temperature gauge |
| 2 LED unit                | 9 Fuel gauge                       |
| 3 Engine tachometer       | 10 HST oil temperature gauge       |
| 4 Speedometer             | 11 Variable speed display          |
| 5 Ecology gauge           | 12 Message pilot lamp              |
| 6 Air conditioner display | 13 Pilot lamps                     |
| 7 Traction level          | 14 DEF level gauge                 |

### Switch panel

- 1 Air conditioner switches / Numeral key pad    2 Function switches

## Visual user menu

Pressing the menu button on the switch panel accesses the user-menu screen. The menus are grouped by function, with easy-to-understand, intuitive icons for easier machine operation.

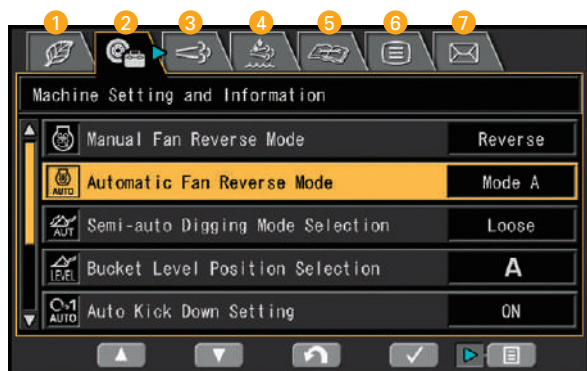
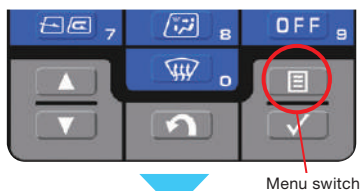

- 1 Energy saving guidance
- 2 Machine settings
- 3 Aftertreatment devices regeneration
- 4 SCR information
- 5 Maintenance
- 6 Monitor setting
- 7 Mail check



## Operator identification function

An operator identification (ID) code can be set for each operator, and used to manage operation information of individual machines through KOMTRAX. Data sent from KOMTRAX can be used to analyze operation status by operator job, as well as by machine.



## Monitor Panel with troubleshooting function minimizes downtime

Various meters, gauges and warning functions are centrally arranged on the monitor panel. The monitor simplifies start-up inspection and warns the operator with a lamp and buzzer if any abnormalities occur. Warnings are indicated in four levels, which the operator must acknowledge and clear.

Replacement times for oil and filters are also indicated.



# MAINTENANCE FEATURES

WA320-8



## Side-opening Gull-wing Engine Doors

The large, gull-wing-type engine doors require minimal effort to open and close, thanks to gas assisted struts. The doors make access and daily maintenance easy. Large steps on each side of the frame also enhance accessibility.



## Auto Reversing Fan

The engine cooling fan is hydraulically driven. It can be set to reverse automatically during operation. Fan reverse mode and timing can be controlled through the monitor.



## Swing-Out Type Cooling Fan and Wide Core Radiator

The cooling fan swings out for easier cleaning. The coolers feature wide-spaced cooling fins to reduce clogging.



## DEF Tank

The DEF tank is easily accessed behind the RH side ladder. An external sight gauge helps prevent overflow and spillage while refilling.



## Battery Disconnect Switch

The battery disconnect switch is located on the right side of the machine. This can be used to disconnect power when performing service work on the machine.





## Engine Compartment

The WA320-8 engine compartment is designed for easy serviceability. Placement of maintenance items, such as filters, dipsticks, and oil-fill locations are laid out for easy-to-reach, ground-level access.

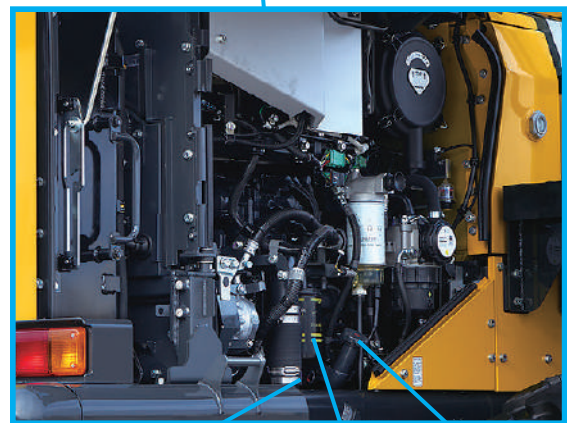
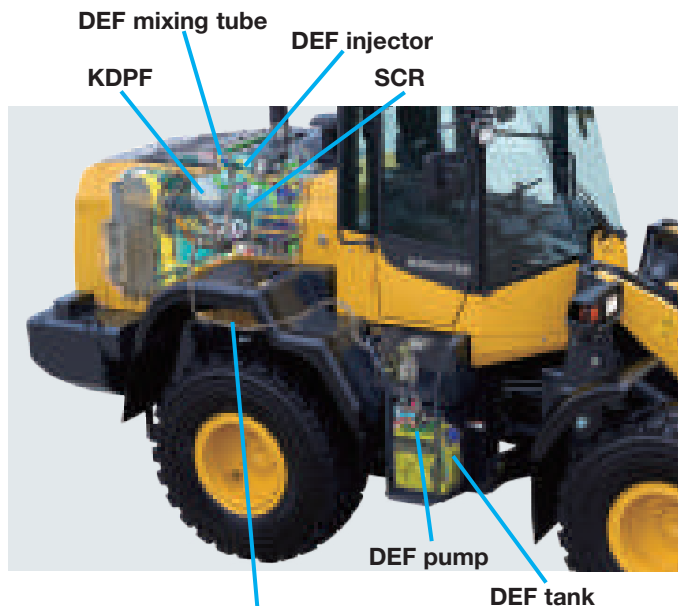

## Rear Full Fenders (Option)

The WA320-8 has a new rear fender option. The rear fenders open upward and use gas-assist struts, which require low lift force.

The fenders swing up with the gull-wing doors to give the technician easy access to the engine compartment. Mud flaps are also included on the rear fenders.



## Cab Air Filter

The inside and outside air filters can be replaced easily without the need for tools. The outside filter is located behind a lockable door for security.

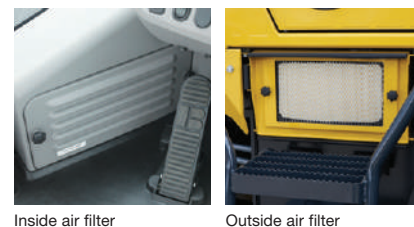

## Maintenance Information

### “Maintenance time caution lamp” display

When the time before required maintenance dips below 30 hours\*, the maintenance-time monitor appears. Pressing the menu switch displays the maintenance screen.

\* : The setting can be changed within the range between 10 and 200 hours.



### Supports DEF level and refill timing

The DEF level gauge is displayed continuously on the monitor panel. In addition, when the refill timing is reached, the DEF-low-level icon appears to alert the operator.

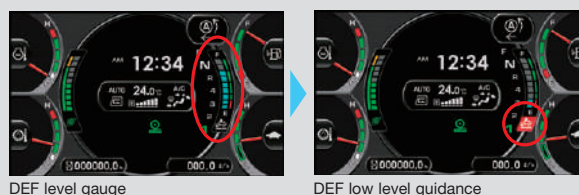

# KOMATSU PARTS & SERVICE SUPPORT



## KOMATSU CARE

### Program Includes:

\*The WA320-8 comes standard with complimentary factory scheduled maintenance for the first 3 Years or 2,000 Hours, whichever comes first.

### Planned Maintenance Intervals at:

500/1000/1500/2000 hour intervals. (250 hr. initial interval for some products) Complimentary Maintenance Interval includes: Replacement of Oils & Fluid Filters with genuine Komatsu Parts, 50-Point inspection, Komatsu Oil & Wear Analysis Sampling (KOWA) / Travel & Mileage (distance set by distributor; additional charges may apply)

### Benefits of Using Komatsu CARE

- Assurance of Proper Maintenance with OEM Parts & Service
- Increased Uptime & Efficiency
- Factory Certified Technicians Performing Work
- Cost of Ownership Savings
- Transferable Upon Resale

### Complimentary KDPF Exchanges

The WA320-8 comes standard with 2 Complimentary KDPF Exchange units for the first 5 Years or 9000 hours whichever comes first. The suggested KDPF Exchange unit service intervals are 4500 hours & 9000 hours. End user must have authorized Komatsu distributor perform the removal & installation of the KDPF.

### Complimentary SCR Maintenance

The WA320-8 also includes 2 factory recommended services of the Selective Catalytic Reduction (SCR) Diesel Exhaust Fluid (DEF) system during the first 5 Years or 9000 hours whichever comes first. The service includes factory recommended DEF tank flush & strainer cleaning at the suggested service intervals of 4500 hours & 9000 hours.

Interval PM	i250	500	1000	1500	2000
CLEAN AC FRESH AND RECIRC AIR FILTERS	✓				
REPLACE HYDRAULIC OIL FILTER ELEMENT	✓				✓
REPLACE HST OIL FILTER	✓		✓		✓
KOWA SAMPLING – (Engine, Front Axle & Rear Axle, Hydraulics, Transfer case)	✓	✓	✓	✓	✓
CHECK AND CLEAN AIR CLEANER	✓	✓	✓	✓	✓
CHECK AND CLEAN FUEL BREATHER ELEMENT	✓	✓	✓	✓	✓
LUBRICATE REAR AXLE PIVOT PIN	✓	✓	✓	✓	✓
LUBRICATE WORK EQUIPMENT	✓	✓	✓	✓	✓
DRAIN SEDIMENT FROM FUEL TANK	✓	✓	✓	✓	✓
COMPLETE 50 POINT INSPECTION FORM; LEAVE PINK COPY WITH CUSTOMER OR IN CAB	✓	✓	✓	✓	✓
RESET MONITOR PANEL MAINTENANCE COUNTER FOR APPROPRIATE ITEMS	✓	✓	✓	✓	✓
CHANGE ENGINE OIL		✓	✓	✓	✓
REPLACE ENGINE OIL FILTER		✓	✓	✓	✓
REPLACE AC FRESH & RECIRC AIR FILTERS		✓	✓	✓	✓
REPLACE FUEL PRE-FILTER		✓	✓	✓	✓
REPLACE FUEL MAIN FILTER			✓		✓
CHANGE OIL IN TRANSFER CASE			✓		✓
CLEAN TRANSFER CASE STRAINER			✓		✓
CLEAN TRANSFER BREATHER			✓		✓
LUBRICATE CENTER HINGE PIN			✓		✓
CHANGE OIL IN HYDRAULIC TANK					✓
REPLACE HYDRAULIC TANK BREATHER ELEMENT					✓
REPLACE DEF TANK BREATHER					✓
REPLACE DEF PUMP FILTER					✓
CLEAN HYDRAULIC TANK STRAINER					✓
CHANGE FRONT AND REAR AXLE OIL					✓
CLEAN BRAKE CIRCUIT STRAINER					✓
REPLACE KCCV FILTER					✓
FACTORY TRAINED TECHNICIAN LABOR	✓	✓	✓	✓	✓
2 KDPF Exchanges at 4,500 Hrs and 9,000 Hrs.					
2 SCR System Maintenance Services at 4,500 Hrs. and 9000 Hrs.					

## Komatsu CARE® – Extended Coverage

- Extended Coverage can provide peace of mind by protecting customers from unplanned expenses that effect cash flow
- Purchasing extended coverage locks-in the cost of covered parts and labor for the coverage period and helps turn these into fixed costs



## Komatsu Parts Support

- 24/7/365 to fulfill your parts needs
- 9 parts Distribution Centers strategically located across the U.S. and Canada
- Distributor network of more than 300 locations across U.S. and Canada to serve you
- Online part ordering through Komatsu eParts
- Remanufactured components with same-as-new warranties at a significant cost reduction



## Komatsu Oil and Wear Analysis (KOWA)

- KOWA detects fuel dilution, coolant leaks, and measures wear metals
- Proactively maintain your equipment
- Maximize availability and performance
- Can identify potential problems before they lead to major repairs
- Reduce life cycle cost by extending component life

\* Certain exclusions and limitations apply. Refer to the customer certificate for complete program details and eligibility. Komatsu® and Komatsu Care® are registered trademarks of Komatsu Ltd. Copyright 2019 Komatsu America Corp.

WA320-8



# KOMTRAX EQUIPMENT MONITORING

GET THE WHOLE STORY WITH  
**KOMTRAX**<sup>®</sup>

✓ **WHAT**

- KOMTRAX is Komatsu's remote equipment monitoring and management system
- KOMTRAX **continuously monitors and records** machine health and operational data
- Information such as fuel consumption, utilization, and a detailed history **lowering owning and operating cost**

✓ **WHEN**

- Know when your machines are **running or idling** and make decisions that will improve your fleet utilization
- Detailed movement records ensure you know when and where your equipment is moved
- Up to date records allow you to **know when maintenance is due** and help you plan for future maintenance needs

✓ **WHERE**

- KOMTRAX data **can be accessed virtually anywhere** through your computer, the web or your smart phone
- Automatic alerts keep fleet managers up to date on the latest machine notifications

✓ **WHY**

- Knowledge is power - **make informed decisions** to manage your fleet better
- Knowing your idle time and fuel consumption will help maximize your machine efficiency
- **Take control of your equipment** - any time, anywhere

✓ **WHO**

- KOMTRAX is **standard** equipment on all Komatsu construction products



**KOMTRAX**<sup>®</sup>

For construction and compact equipment.

**KOMTRAX Plus**<sup>®</sup>

For production and mining class machines.

# SPECIFICATIONS



## ENGINE

Model..... Komatsu SAA6D107E-3\*  
 Type..... Water-cooled, 4-cycle  
 Aspiration..... Variable geometry turbo-charged,  
 after-cooled, cooled EGR  
 Number of cylinders..... 6  
 Bore..... 107 mm **4.21"**  
 Stroke..... 124 mm **4.88"**  
 Piston displacement..... 6.69 ltr **408 in<sup>3</sup>**  
 Governor..... All-speed, electronic  
 Horsepower:  
   SAE J1995..... Gross 127 kW **170 HP**  
   ISO 9249 / SAE J1349..... Net 123 kW **165 HP**  
   Rated rpm..... 2100 rpm  
   Max power - ISO 14396..... 126 kW **169 HP @ 1900 rpm**  
 Fan drive method for radiator cooling..... Hydraulic  
 Fuel system..... Direct injection  
 Lubrication system:  
   Method..... Gear pump, force-lubrication  
   Filter..... Full-flow type  
 Air cleaner..... Dry type with double elements and  
 dust evacuator, plus dust indicator

\*EPA Tier 4 Final emissions certified



## TRANSMISSION

Transmission..... Hydrostatic, 1 pump, 2 motors  
 with speed range select

Travel speed	Forward	Reverse
<b>1st</b>	1.0 - 13.0 km/h <b>0.6 - 8.1 mph</b>	1.0 - 13.0 km/h <b>0.6 - 8.1 mph</b>
<b>2nd</b>	13.0 km/h <b>8.1 mph</b>	13.0 km/h <b>8.1 mph</b>
<b>3rd</b>	18.7 km/h <b>11.6 mph</b>	18.7 km/h <b>11.6 mph</b>
<b>4th</b>	38.0 km/h <b>23.6 mph</b>	38.0 km/h <b>23.6 mph</b>

Measured with 20.5-R25 tires



## AXLES AND FINAL DRIVES

Drive system..... Four-wheel drive  
 Front..... Fixed, semi-floating  
 Rear..... Center-pin support, semi-floating,  
 24° total oscillation  
 Reduction gear..... Spiral bevel gear  
 Differential gear..... Torque proportioning  
 Final reduction gear..... Planetary gear, single reduction



## BRAKES

Service brakes..... Hydraulically actuated,  
 wet disc brakes actuate on four wheels  
 Parking brake..... Wet, multi-disc brake on transfer output shaft  
 Secondary brake..... Parking brake is commonly used



## STEERING SYSTEM

Type..... Articulated type, fully-hydraulic power steering  
 Steering angle..... 38.5° each direction (40° to max end stop)  
 Minimum turning radius at  
 the center of outside tire..... 5380 mm **17' 8"**



## HYDRAULIC SYSTEM

Steering system:  
 Hydraulic pump..... Piston pump, in common  
 with loader control  
 Capacity..... 180 ltr/min **47.6 U.S. gal/min** at rated rpm  
 Relief valve setting..... 20.6 MPa 210 kgf/cm<sup>2</sup> **3,000 psi**  
 Hydraulic cylinders:  
   Type..... Double-acting, piston type  
   Number of cylinders..... 2  
   Bore x stroke..... 70 mm x 453 mm **2.76" x 17.8"**

Loader control:  
 Hydraulic pump..... Piston pump, in common  
 with steering system  
 Capacity..... 180 ltr/min **47.6 U.S. gal/min** at rated rpm  
 Relief valve setting..... 30.4 MPa 310 kgf/cm<sup>2</sup> **4,410 psi**  
 Hydraulic cylinders:  
   Type..... Double-acting, piston type  
   Number of cylinders—bore x stroke:  
     Lift cylinder..... 2- 120 mm x 729 mm **4.7" x 28.7"**  
     Bucket cylinder..... 1- 150 mm x 558 mm **5.9" x 22"**  
   Control valve..... 2-spool type  
 Control positions:  
   Boom..... Raise, hold, lower, and float  
   Bucket..... Tilt-back, hold, and dump  
 Hydraulic cycle time (rated load in bucket)  
   Raise..... 6.3 sec  
   Dump..... 1.9 sec  
   Lower (Empty)..... 3.5 sec



## SERVICE REFILL CAPACITIES

Cooling system..... 35.1 ltr **9.3 U.S. gal**  
 Fuel tank..... 245 ltr **64.7 U.S. gal**  
 Engine..... 23 ltr **6.1 U.S. gal**  
 Hydraulic system..... 92 ltr **24.3 U.S. gal**  
 Axle front..... 27 ltr **7.1 U.S. gal**  
 Axle rear..... 25.5 ltr **6.7 U.S. gal**  
 Transfer case..... 5.8 ltr **1.5 U.S. gal**  
 DEF tank..... 14 ltr **3.7 U.S. gal**



## BUCKET SELECTION GUIDE

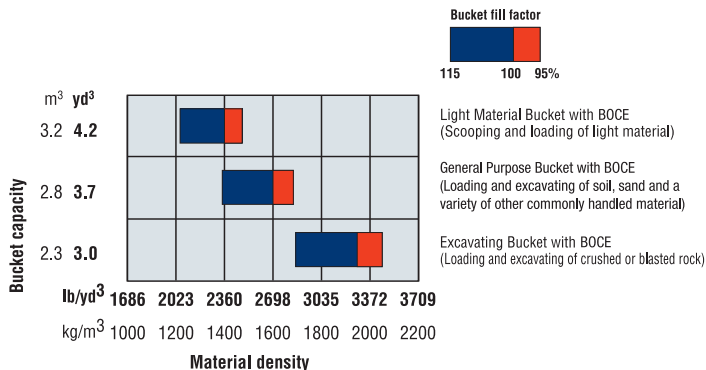





## DIMENSIONS

Measured with 20.5-R25(L3) tires, ROPS/FOPS cab

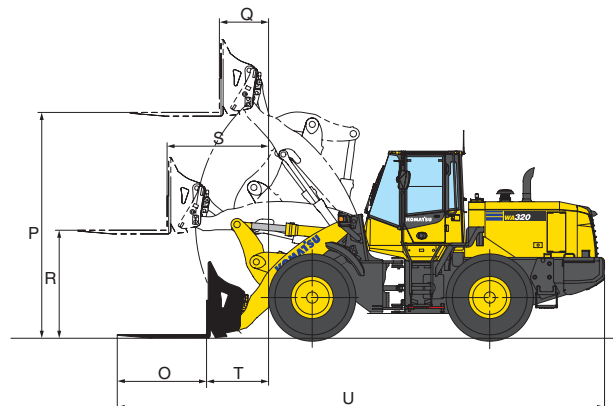
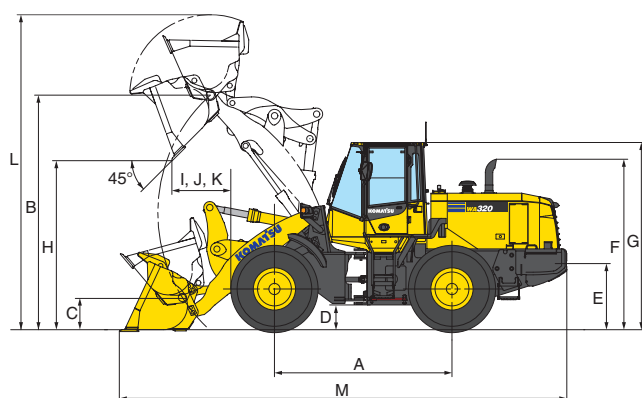

Tread		2050 mm	<b>6'9"</b>
Width over tires		2590 mm	<b>8'6"</b>
A Wheelbase		3030 mm	<b>9'11"</b>
B Hinge pin height,	Standard Boom	4005 mm	<b>13'2"</b>
max. height	High Lift Boom	4545 mm	<b>14'11"</b>

C Hinge pin height,	Standard Boom	545 mm	<b>1'9"</b>
carry position	High Lift Boom	705 mm	<b>2'4"</b>
D Ground clearance		425 mm	<b>1'5"</b>
E Hitch height		1085 mm	<b>3'7"</b>
F Overall height, top of the stack		3040 mm	<b>10'0"</b>
G Overall height, ROPS cab		3200 mm	<b>10'6"</b>

## BUCKET

	General Purpose Bucket w/ Pin On		Light Material Bucket w/ Pin On		Excavating Bucket w/ Pin On		General Purpose Bucket w/ Quick Coupler		High Lift General Purpose Bucket w/ Pin On	
	B.O.C.E.	B.O.C.E.	B.O.C.E.	B.O.C.E.	B.O.C.E.	B.O.C.E.	B.O.C.E.	B.O.C.E.	B.O.C.E.	
Bucket capacity: heaped	2.8 m <sup>3</sup>	3.2 m <sup>3</sup>	2.3 m <sup>3</sup>	2.7 m <sup>3</sup>	2.3 m <sup>3</sup>	3.0 yd <sup>3</sup>	3.5 yd <sup>3</sup>	3.0 yd <sup>3</sup>	3.0 yd <sup>3</sup>	
struck	2.4 m <sup>3</sup>	2.8 m <sup>3</sup>	1.9 m <sup>3</sup>	2.2 m <sup>3</sup>	1.9 m <sup>3</sup>	3.1 yd <sup>3</sup>	3.7 yd <sup>3</sup>	2.9 yd <sup>3</sup>	2.5 yd <sup>3</sup>	
Bucket width	2740 mm	2740 mm	2740 mm	2740 mm	2740 mm	9'0"	9'0"	9'0"	9'0"	
Bucket weight	1330 kg	1445 kg	1370 kg	1260 kg	1255 kg	2,932 lb	3,186 lb	2,778 lb	2,767 lb	
H Dumping clearance, max. height and 45° dump angle*	2880 mm	2745 mm	2965 mm	2785 mm	3525 mm	9'5"	9'0"	9'2"	11'7"	
I Reach at max. height and 45° dump angle*	1000 mm	1110 mm	840 mm	1240 mm	980 mm	3'3"	3'8"	4'1"	3'3"	
J Reach at 2130 mm 7° clearance and 45° dump angle*	1595 mm	1620 mm	1540 mm	1765 mm	2060 mm	5'3"	5'4"	5'9"	6'9"	
K Reach with arm horizontal and bucket level*	2500 mm	2665 mm	2350 mm	2735 mm	2825 mm	8'2"	8'9"	9'0"	9'3"	
L Operating height (fully raised)	5375 mm	5465 mm	5175 mm	5425 mm	5845 mm	17'8"	17'11"	17'10"	19'2"	
M Overall length (bucket on ground)	7690 mm	7855 mm	7540 mm	7840 mm	8125 mm	25'3"	25'9"	25'9"	26'8"	
Loader clearance circle (bucket at carry, outside corner of bucket)	12620 mm	12715 mm	12500 mm	12655 mm	13010 mm	41'5"	41'9"	41'0"	41'6"	
Digging depth: 0°	165 mm	165 mm	165 mm	65 mm	270 mm	6.5"	6.5"	6.5"	3"	
10°	375 mm	410 mm	350 mm	320 mm	460 mm	1'3"	1'4"	1'2"	1'0"	
Static tipping load: straight	11500 kg	11410 kg	11485 kg	11255 kg	9175 kg	25,353 lb	25,155 lb	25,320 lb	24,813 lb	
40° full turn	9780 kg	9670 kg	9745 kg	9520 kg	7710 kg	21,561 lb	21,319 lb	21,484 lb	20,988 lb	
Breakout force	162 kN	139 kN	185 kN	140 kN	197 kN	36,310 lb	31,151 lb	41,601 lb	31,473 lb	
Operating weight	15480 kg	15600 kg	15520 kg	15870 kg	15680 kg	34,128 lb	34,392 lb	34,216 lb	34,987 lb	

\* At the end of tooth or B.O.C.E.

All dimensions, weights, and performance values based on SAE J732c and J742b standards. Static tipping load and operating weight shown include lubricant, coolant, full fuel tank, ROPS cab and operator. Machine stability and operating weight affected by tire size and attachments.

## FORK

	Fork With Quick Coupler
O Fork tine length	1524 mm 5'0"
P Ground to top of tine at maximum lift	3855 mm 12'7"
Q Reach at maximum lift	840 mm 2'9"
R Ground to top of tine - boom and tine level	1845 mm 6'0"
S Reach - boom and tine level	1730 mm 5'8"
T Reach - tine level on ground	1060 mm 3'6"
U Overall length - tine level on ground	8375 mm 27'6"
Static tipping load - boom level: straight	8550 kg
fork level, tine center	18,850 lb
40° full turn	7440 kg
Operating weight	15140 kg 33,378 lb

Operating load per SAE J1197 (Feb. 1991), 50% of static tipping load.

Static tipping load and operating weight shown include lubricant, coolant, full fuel tank, ROPS cab and operator. Machine stability and operating weight affected by tire size and attachments.



## WEIGHT CHANGES

Tires or attachments	Change in operating weight		Change in tipping load				Width over tires		Ground clearance		Change in vertical dimensions	
	kg	lb	Straight		Full turn		mm	ft in	mm	ft in	mm	ft in
			kg	lb	kg	lb						
20.5-25-12PR (L2)	-165	-364	-105	-231	-95	-209	2585	8'6"	425	1'5"	0	0
Remove additional counterweight	-250	-551	-440	-970	-380	-838	0	0	0	0	0	0



## STANDARD EQUIPMENT

- 2-spool valve for boom and bucket control
- Alternator, 24 V/ 90 A
- Automatic hydraulic-driven fan with automatic reverse rotation
- Back-up alarm
- Batteries, 92 Ah/12V (2), 680 CCA
- Battery disconnect
- Boom kick-out, in-cab adjustable
- Bucket positioner
- Color, rear-view camera and monitor
- Counterweight, standard and additional
- Electronically Controlled Suspension System
- Engine, Komatsu SAA6D107E-3 diesel
- Engine shut-off system, electric
- Equipment Management Monitoring System (EMMS)
  - Lights (central warning, brake oil pressure, engine oil pressure, parking brake, cooling fan reverse, KDPF restriction, seat belt caution, Komtrax message)
  - Gauges (DEF level, Engine water temperature, ecology, Fuel level, HST oil temperature, speedometer/tachometer), variable speed display
- Front fenders
- Fuel pre-filter with water separator
- Horn, electric
- Hydrostatic transmission
- Komatsu SmartLoader Logic
- Komatsu Auto Idle Shutdown
- KOMTRAX® Level 5
- Lift cylinders and bucket cylinder
- Lights
  - Back-up light
  - Stop and tail light
  - Turn signal lamps, 2 front and 2 rear with hazard switch
  - Working lights, halogen, 2 front cab mount
  - Working lights, halogen, 2 front fender mount
  - Working lights, halogen, 2 rear grill mount
- Loader linkage with standard lift arm
- Multifunction mono-lever loader control with transmission F/R switch
- Parking brake, electric
- Radiator, wider core
- Radiator mask, swing up
- Rear view mirrors, outside (2) inside (2)
- Rims for 20.5-R25 tires
- ROPS/FOPS Cab Level 2
  - 2 x DC12V electrical outlets
  - Ashtray
  - Auto air conditioner
  - Cigarette lighter, 24V
  - Color LCD/TFT multi-monitor
  - Cup holder
  - Floor mat
  - Operator seat, reclining, air suspension type, heated
  - Radio, AM/FM with AUX input jack
  - Rear defroster, electric
  - Seatbelt, 2-point retractable, 76mm 3" width
  - Space for lunch box
  - Steering wheel, tilt and telescopic
  - Sun visor, front window
  - Windshield washer and wiper, front with intermittent
  - Windshield washer and wiper, rear
- Service brakes, wet disc type
- Starting motor, 5.5 kW
- Transmission speed ranges, 4 forward and 4 reverse
- Vandalism protection kit, padlocks for battery box (2)



## OPTIONAL EQUIPMENT

- Auxiliary steering (SAE)
- Cutting edge (bolt-on type)
- Engine oil and coolant heater
- Guarding package
- Limited slip differential (F&R)
- Lube system
- Quick coupler
- Rear full fenders
- Three-spool valve (will utilize integrated proportional control switch included in the multi-function mono-lever) and piping
- Various tire options, radial and bias
- Various bucket options

AESS903-02

©2016 Komatsu America Corp.

Printed in USA

AD08(2.5M)OTP

02/19 (EV-4)

# KOMATSU®

*Note: All comparisons and claims of improved performance made herein are made with respect to the prior Komatsu model unless otherwise specifically stated.*

www.komatsuamerica.com

Komatsu America Corp. is an authorized licensee of Komatsu Ltd. Materials and specifications are subject to change without notice

**KOMATSU**, Komatsu Care®, KOMTRAX® and KOMTRAX Plus® are registered trademarks of Komatsu Ltd. All other trademarks and service marks used herein are the property of Komatsu Ltd., Komatsu America Corp. or their respective owners or licensees.