

KOMATSU®

WA470-8

Tier 4 Final Engine

WHEEL LOADER

WA470



Photos may include optional equipment.

NET HORSEPOWER

272 HP @ 2000 rpm
203 kW @ 2000 rpm

OPERATING WEIGHT

53,352– 55,579 lb
24,200 – 25,210 kg

BUCKET CAPACITY

5.0 – 5.8 yd³
3.8 – 4.4 m³

WALK-AROUND



WA470-8

Photos may include optional equipment.

NET HORSEPOWER

272 HP @ 2000 rpm
203 kW @ 2000 rpm

OPERATING WEIGHT

53,352 – 55,579 lb
24,200 – 25,210 kg

BUCKET CAPACITY

5.0 – 5.8 yd³
3.8 – 4.4 m³



PERFORMANCE, DURABILITY AND FUEL ECONOMY

Large capacity torque converter with lock-up:

- Quick acceleration
- Lock-up in 2nd, 3rd and 4th gear

Komatsu SmartLoader Logic helps reduce fuel consumption with no decrease in production.



A powerful **Komatsu SAA6D125E-7 engine** provides a net output of 203 kW **272 HP** with 6% improved fuel consumption. This engine is EPA Tier 4 Final emissions certified.

Variable Geometry Turbocharger (VGT) uses a hydraulic actuator to provide optimum air flow under all speed and load conditions.

Komatsu Diesel Particulate Filter (KDPF) and Selective Catalytic Reduction (SCR) systems reduce particulate matter and NOx while providing automatic regeneration that does not interfere with daily operation.

Fluid neutral or better

Fuel & DEF total consumption is less than fuel consumed by the prior model.

Cooling

- Hydraulically driven, variable speed
- Auto-reversing fan is standard
- Wider core coolers resist clogging
- Swing out fan for easy cleaning

Remote boom and bucket positioners can set kick-outs from inside the cab.

Variable displacement piston pumps with CLSS provides quick response and smooth operation to maximize productivity.

Rearview monitoring system (standard)

Advanced diagnostic system continuously monitors machine operation and vital systems to identify machine issues and assist with troubleshooting.

Transmission Mode Select System (3 modes) allows shifting mode to be matched more efficiently to varying work applications.

Enhanced working environment:

- High capacity air suspension seat, heated
- Seat mounted EPC controls with F-N-R switch
- (2) 12V power outlets

New style of front fender is plastic for durability.

Rear full fenders (standard) are made of durable plastic and swing open for easy access to maintenance points.

Large LCD color monitor panel:

- 7" high resolution, multi-color screen is easy to read
- Provides "Ecology Guidance" for fuel efficient operation
- Onboard diagnostics do not require use of a laptop computer
- Multiple choice, pulldown menus are filled with useful functions

Komatsu Auto Idle Shutdown helps reduce idle time and operating costs.

External mounting of engine air filter (above rear LH fender)

provides easy access for maintenance.

KOMTRAX® equipped machines can send location, SMR and operation maps to a secure website or smart phone utilizing wireless technology. Machines also relay error codes, cautions, maintenance items, fuel & Diesel Exhaust Fluid (DEF) levels, and much more.

Battery disconnect switch allows a technician to disconnect the power supply before servicing the machine.

Operator Identification System can track machine operation for up to 100 operators.

PERFORMANCE FEATURES

KOMATSU NEW ENGINE TECHNOLOGIES

New Tier 4 Final Engine

The Komatsu SAA6D125E-7 engine is EPA Tier 4 Final emissions certified and provides exceptional performance while reducing fuel consumption. Based on Komatsu proprietary technologies developed over many years, this new diesel engine reduces nitrogen oxides (NOx) by more than 80% when compared to Tier 4 interim levels.

Technologies Applied to New Engine

Heavy-duty aftertreatment system

This new system combines a Komatsu Diesel Particulate Filter (KDPF) and Selective Catalytic Reduction (SCR). The SCR NOx reduction system injects the correct amount of Diesel Exhaust Fluid (DEF) at the proper rate, thereby decomposing NOx into non-toxic water vapor (H₂O) and nitrogen gas (N₂).

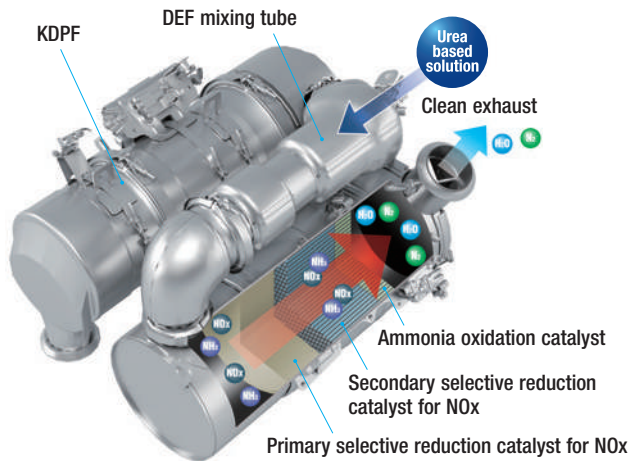

Heavy-duty cooled Exhaust Gas Recirculation (EGR) system

The system recirculates a portion of exhaust gas into the air intake and lowers combustion temperatures, thereby reducing NOx emissions. EGR gas flow has been decreased for Tier 4 Final with the addition of SCR technology. The system dramatically reduces NOx, while helping cut fuel consumption below Tier 4 Interim levels.

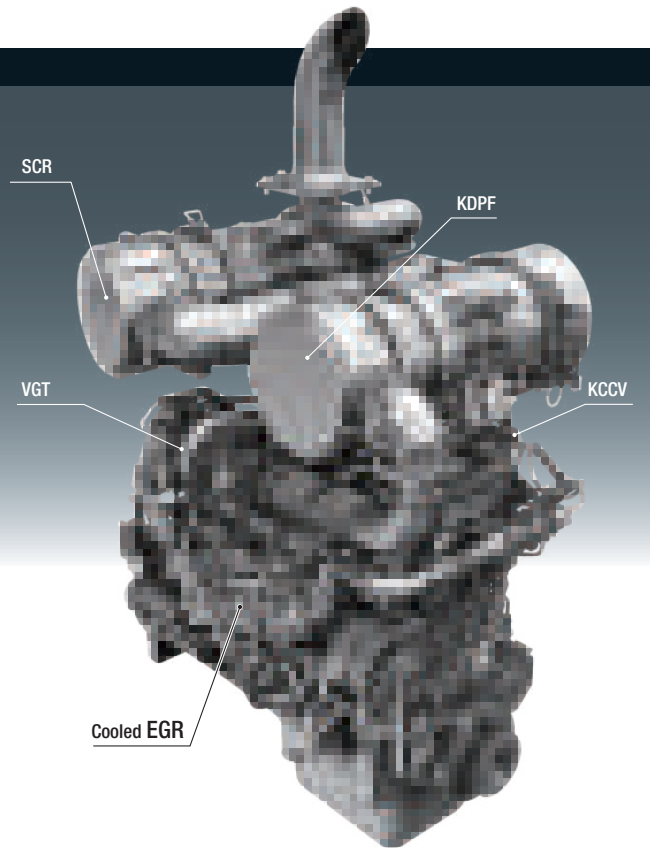
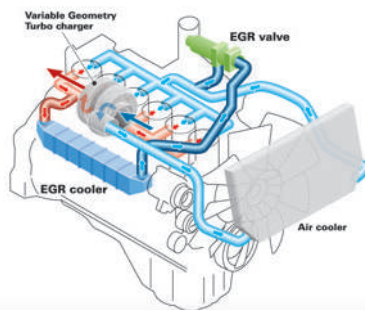

Advanced Electronic Control System

The electronic control system performs high-speed processing of all signals from sensors installed in the vehicle providing total control of equipment. Engine condition information is displayed on the monitor inside the cab, providing necessary information to the operator. Additionally, managing the information via KOMTRAX helps customers keep up with required maintenance.

Variable Geometry Turbocharger (VGT) system

The VGT system features proven Komatsu design hydraulic technology for variable control of air-flow and supplies optimal air according to load conditions. The upgraded version provides better exhaust temperature management.

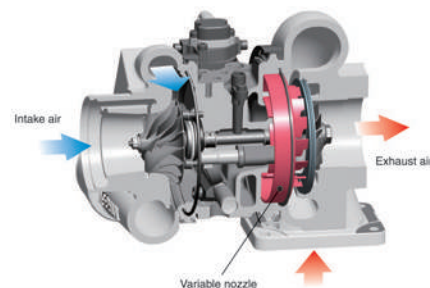

Heavy-duty High-Pressure Common Rail (HPCR) fuel injection system

The system is designed to achieve an optimal injection of high-pressure fuel digitally, thereby bringing near complete combustion to reduce PM emissions.

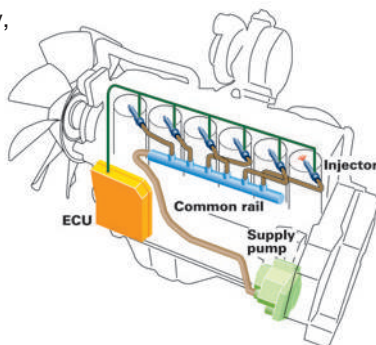

Komatsu SmartLoader Logic

The WA470-8 provides Komatsu SmartLoader Logic, an engine control system. This technology creates enough torque for each work phase. For example, engine torque needs are higher for digging in V-shape loading, but less when driving with an empty bucket. This system optimizes the engine torque for all applications to minimize fuel consumption. Komatsu SmartLoader Logic functions automatically and doesn't interfere with operation, saving fuel without decreasing production.

Large-capacity Torque Converter

The Komatsu designed power train has a large capacity torque converter for optimum efficiency. The WA470-8 has greater productivity in V-shape loading applications because the increased tractive effort does not require full throttle. The improved hill climbing ability allows the WA470-8 to up-shift gears faster because of improved acceleration. The WA470-8 can achieve higher gear ranges and maintain higher travel speed when working in load-and-carry applications. In most applications, production is increased and fuel consumption is reduced, resulting in improved fuel efficiency.

Enhanced Lock-up

The Komatsu designed torque converter with lock-up is standard on the WA470-8. The lock-up function activates in 2nd, 3rd and 4th gears. The lock-up torque converter is effective for both load and carry application and V-shape loading which uses lower gears. Komatsu SmartLoader Logic reduces the clutch engagement shock of lock-up by controlling engine torque. The lock-up torque converter combined with Komatsu SmartLoader Logic results in low fuel consumption and high travel speeds in load and carry and even some V-cycle loading applications.

Dual-mode Engine Power Select System

This wheel loader offers two selectable operating modes – E and P.

- E Mode: This mode provides maximum fuel efficiency for general loading.
- P Mode: This mode provides maximum power output for hard digging operation or hill climbing.



1 Dual mode engine power selection switch
2 Transmission shift mode selector switch
3 Torque converter lock-up switch

Automatic Transmission with Mode Select System

This operator controlled system allows the operator to select manual shifting or two levels of automatic shifting (low, and high). Auto L mode is for fuel saving operation with the gear shift timing set at lower speeds than Auto H mode. Therefore Auto L mode keeps the engine in a relatively low rpm range for fuel conservation while yielding required tractive force by operator depressing the accelerator pedal.

Variable Displacement Piston Pump & CLSS

The variable displacement piston pump combined with the Closed-center Load Sensing System (CLSS) delivers hydraulic flow just as the job requires preventing wasted hydraulic flow. Minimized loss contributes to better fuel economy.

Komatsu Auto Idle Shutdown

In order to reduce idle time, Komatsu offers Komatsu Auto Idle Shutdown. This function will shut the engine off and apply the parking brake and hydraulic lock after a preset idle time limit. This time limit can be set by the operator or service technician and may range from 3 minutes to 60 minutes.

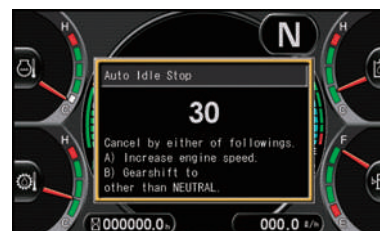

OPERATOR ENVIRONMENT



WA470-8

New Operator Seat with Electronic Pilot Control (EPC) Levers

A new air suspension seat provides enhanced support on rough roads and dampens machine vibrations, providing a more comfortable ride for the operator. An EPC lever console is integrated in the seat and moves with the seat. The angle of the armrest is fully adjustable for optimum operator comfort. A secondary F-N-R switch is incorporated in work equipment lever configurations. A heated seat is standard.



Tiltable / Telescopic Steering Wheel

The operator can both tilt and telescope the steering wheel to allow maximum comfort and control. The two spoke steering wheel allows maximum visibility of the monitor panel and the forward work environment.



Low Noise Design

Operator's ear noise level : 72 dB(A)
Dynamic noise level (outside): 108 dB(A)

The large cab is mounted with Komatsu's unique ROPS/FOPS viscous mounts. The low-noise engine, hydraulically driven fan, and hydraulic pumps are mounted with rubber cushions, and the cab sealing is improved to provide a quiet, low-vibration, dust-proof, and comfortable operating environment.

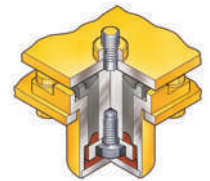

Mono-lever with Integrated 3rd Spool Control (Optional)

The mono-lever allows the operator to control the optional 3rd spool with your thumb which greatly increases ease of operation. The 3rd spool valve can be operated in either continuous or proportional flow modes. The mono-lever also includes a F-N-R switch.

Joystick/Wheel Steering Control System (optional)

allows steering and directional travel to be controlled by wrist and finger control to minimize operator fatigue.





Rear View Monitoring System (standard)

The operator can view the rear of the machine with a full color monitor that is located on the right side of the cab. This monitor can be always on or only on when the loader goes into reverse. Visual guidelines can also be added for more convenience.



Engine Shutdown Secondary Switch

The engine stop switch is incorporated to allow shutdown of the machine when accessing the key switch is not possible.

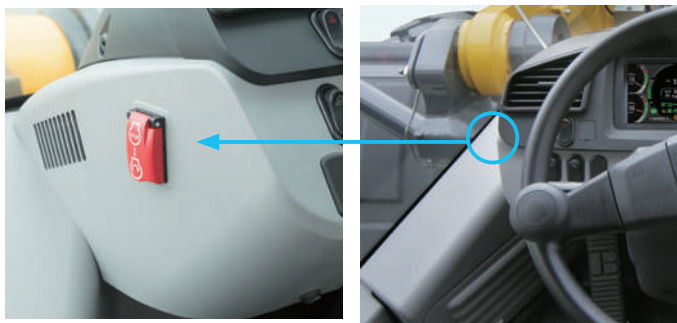

Auxiliary Input (MP3 Jack) 12 V Outlets

An Aux input for digital devices is standard as well as two 12 volt outlets. These are all located on the front of the right hand console.

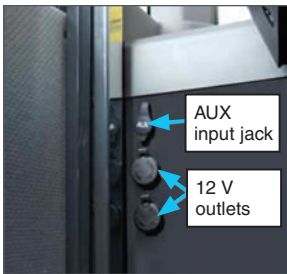

WORKING ENVIRONMENT



Easy Entry and Egress

The WA470-8 has an inclined ladder with wide steps and hand holds to ease entry and exit from the cab.

Remote Bucket & Boom Positioner

The operator can set the bucket angle and remote boom positioner from the cab. Both upper and lower boom positions are adjustable in the cab with the push of a button. The bucket positioner can memorize three horizontal settings, allowing the operator to easily change attachments without having to reset the bucket position. In each horizontal setting, the operator can adjust the setting with the switch in the cab. This can help save the operator time when changing attachments.



Remote positioner switch
Boom / Bucket

Automatic Kick-down

The WA470-8 has the ability to automatically shift down to F1. This can be activated through the monitor.



Electronically Controlled Suspension System (ECSS)

The Electronically Controlled Suspension System (ECSS) or ride control system uses an accumulator which minimizes boom arm shock, giving the operator a much smoother ride. This reduces operator fatigue and reduces material spillage during load and carry operations. ECSS is speed sensitive, meaning that the boom won't move during stationary digging. ECSS is standard on the WA470-8.

Mono Lever With Integrated 3rd Spool Control (option)

The mono lever option has been designed for improved ergonomics and comfort. When equipped with the optional 3rd spool valve, it allows the operator to control the 3rd spool with the thumb. The 3rd spool valve can be operated in either continuous or proportional flow modes. The mono lever also includes a F-N-R switch.

High Resolution 7-inch Color LCD Monitor

The machine monitor display various machine information and allows for various settings of the machine. The LCD monitor is a 7-inch color TFT-LCD and displays maintenance information, operation record, Ecology Guidance record, and other machine data. The switch panel is used to select various screens and the air conditioner control screen. By using the switch panel, you can display various user menus on the LCD screen and adjust the machine settings.

Machine monitor

- | | |
|---------------------------|---|
| 1 LCD unit | 8 Engine coolant temperature gauge |
| 2 LED unit | 9 Hydraulic oil temperature gauge |
| 3 Engine tachometer | 10 Torque converter oil temperature gauge |
| 4 Speedometer | 11 Fuel gauge |
| 5 Ecology gauge | 12 Message pilot lamp |
| 6 Air conditioner display | 13 Pilot lamps |
| 7 Shift indicator | 14 DEF level gauge |

Switch panel

- | | |
|--|---------------------|
| 1 Air conditioner switches / Numeral key pad | 2 Function switches |
|--|---------------------|

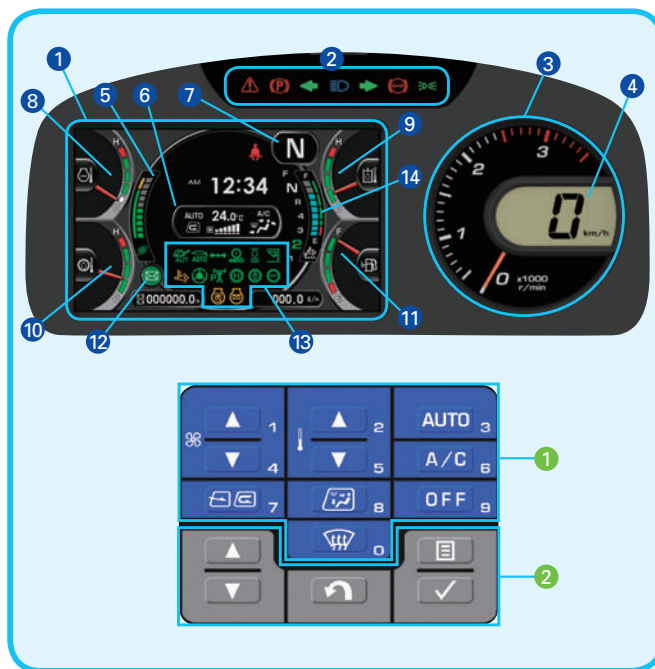

Visual user menu

Pressing the menu switch on the switch panel displays the user menu screen. The menus are grouped for each function, and use easy-to-understand icons which enable the machine to be operated intuitively.

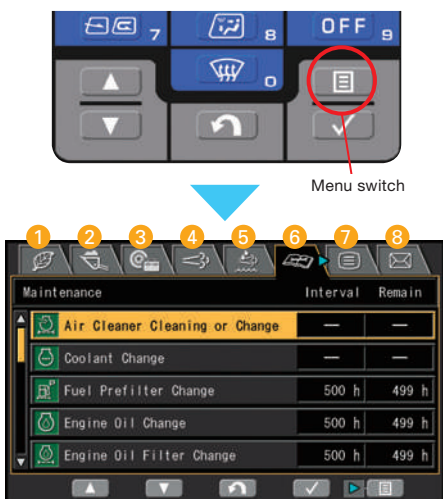

- 1 Energy saving guidance
- 2 Load meter setting (optional)
- 3 Machine settings
- 4 Aftertreatment devices regeneration
- 5 SCR information
- 6 Maintenance
- 7 Monitor setting
- 8 Mail check

Operator identification function

An operator identification (ID) can be set for each operator, and used to manage operation information of individual machines as KOMTRAX data. Data sent from KOMTRAX can be used to analyze operation status by operator as well as by machine.



Machine monitor with troubleshooting function to minimize downtime

Various meters, gauges and warning functions are centrally arranged on the machine monitor. The monitor simplifies start-up inspection and promptly warns the operator with a lamp and buzzer if any abnormalities should occur. In addition, countermeasures are indicated in 4 levels to ensure safety and help prevent the machine from having major problems. Replacement times for oil and filters are also indicated.



MAINTENANCE FEATURES



WA470-8

Side-opening Gull-wing Engine Doors

The large gull-wing type engine doors require less effort to open and close thanks to gas assisted struts. The doors provide wide areas of access for ease of daily maintenance. Large steps on each side of the frame enhance accessibility.



Swing-out Type Cooling Fan and Wide Core Radiator

The cooling fan swings out for cleaning. The coolers feature wide spacing of the cooling fins to reduce clogging.



Auto Reversing Fan

The engine cooling fan is driven hydraulically. It can be set to reverse automatically during operation. Fan reverse mode and timing can be controlled through the monitor.



DEF Tank

The DEF tank is located on the right hand side of the machine behind a ladder for easy access. An external sight gauge aids in preventing overflow and spillage while refilling.



Battery Disconnect Switch

The battery disconnect switch is located in the right side of the engine. This can be used to disconnect power when performing service work on the machine.



Engine Compartment

The WA470-8 engine compartment is designed for easy serviceability. Placement of maintenance items, such as filters, dipsticks, oil fill locations, and aftertreatment devices is all very intuitive.

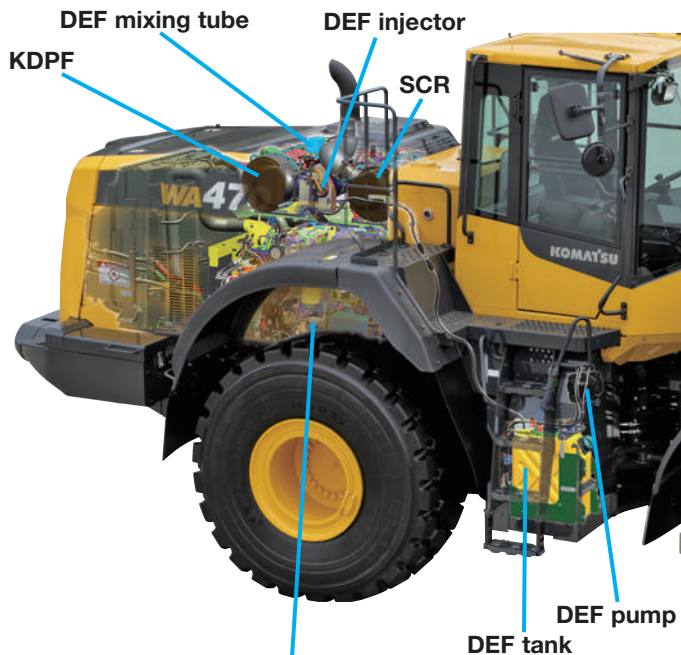

Engine oil fill
Engine oil dipstick
Fuel filter
Fuel pre-filter
Oil filter

Rear Full Fenders (Standard)

The WA470-8 has a rear full fender standard. The plastic rear fenders open outward, keeping the force to open the engine doors low, even when there is mud or snow on the fenders. The fenders swing far out of the way to give the technician easy access to the engine compartment. Mudflaps are also included on the rear fenders.



Air Conditioner Filter

The inside and outside air conditioner filters can be replaced easily without using a tool. The outside filter is located behind a lockable door for security.



Inside air filter

Outside air filter

LED Taillights

LED brake lights and LED reverse lights provide long bulb life.



Air Cleaner

The air cleaner is located on the left side platform for easy access.



Maintenance Information

“Maintenance time caution lamp” display

When the remaining time to maintenance becomes less than 30 hours*, the maintenance time monitor appears. Pressing the menu switch displays the maintenance screen.

* : The setting can be changed within the range between 10 and 200 hours.



Maintenance screen

Supports the DEF level and refill timing

The DEF level gauge is displayed continuously on the monitor screen. In addition, when the refill timing is reached, the DEF low level guidance appears as a pop up display to inform the operator in real time.

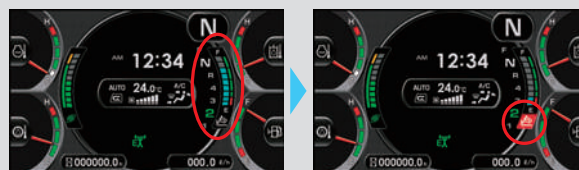

DEF level gauge

DEF low level guidance

KOMATSU PARTS & SERVICE SUPPORT



Every new Komatsu Tier 4 Final construction machine is covered.

The Komatsu CARE program covers all new Komatsu Tier 4 Final construction equipment, whether rented, leased or purchased. For the first 3 years or 2,000 hours, whichever occurs first, you'll receive:

- Regular service at 500, 1,000, 1,500 and 2,000-hr. intervals
- DEF tank breather element replacement at 1,000 hours
- DEF and CCV filters replacement at 2,000 hours
- 50-point inspection by factory-trained technician at each scheduled interval
- Technician labor
- Fluids, oils, coolant, filters, SCR screen, tank breather and parts
- Technician travel to and from your equipment location

Plus two complimentary scheduled KDPF exchanges and SCR system service for 5 years-no hours limits.*

Service will be performed by a Komatsu Distributor and only Komatsu genuine fluids and filters will be used.

Komatsu CARE® services are available from every Komatsu Distributor in the U.S. and Canada.



Komatsu CARE® – Extended Coverage

- Extended Coverage can provide peace of mind by protecting customers from unplanned expenses that effect cash flow
- Purchasing extended coverage locks-in the cost of covered parts and labor for the coverage period and helps turn these into fixed costs



* Some exclusions apply. Please contact your Komatsu distributor for specific program details.



Komatsu Parts Support

- 24/7/365 to fulfill your parts needs
- 9 parts Distribution Centers strategically located across the U.S. and Canada
- Distributor network of more than 300 locations across U.S. and Canada to serve you
- Online part ordering through Komatsu eParts
- Remanufactured components with same-as-new warranties at a significant cost reduction



Komatsu Oil and Wear Analysis (KOWA)

- KOWA detects fuel dilution, coolant leaks, and measures wear metals
- Proactively maintain your equipment
- Maximize availability and performance
- Can identify potential problems before they lead to major repairs
- Reduce life cycle cost by extending component life

WA470-8

KOMTRAX EQUIPMENT MONITORING

GET THE WHOLE STORY WITH
KOMTRAX[®]

✓ **WHAT**

- KOMTRAX is Komatsu's remote equipment monitoring and management system
- KOMTRAX **continuously monitors and records** machine health and operational data
- Information such as fuel consumption, utilization, and a detailed history **lowering owning and operating cost**

✓ **WHEN**

- Know when your machines are **running or idling** and make decisions that will improve your fleet utilization
- Detailed movement records ensure you know when and where your equipment is moved
- Up to date records allow you to **know when maintenance is due** and help you plan for future maintenance needs

✓ **WHERE**

- KOMTRAX data **can be accessed virtually anywhere** through your computer, the web or your smart phone
- Automatic alerts keep fleet managers up to date on the latest machine notifications

✓ **WHY**

- Knowledge is power - **make informed decisions** to manage your fleet better
- Knowing your idle time and fuel consumption will help maximize your machine efficiency
- **Take control of your equipment** - any time, anywhere

✓ **WHO**

- KOMTRAX is **standard** equipment on all Komatsu construction products



KOMTRAX[®]

For construction and compact equipment.

KOMTRAX Plus[®]

For production and mining class machines.

SPECIFICATIONS



ENGINE

Model.....Komatsu SAA6D125E-7*
 Type.....Water-cooled, 4-cycle
 Aspiration.....Turbo-charged, after-cooled, cooled EGR
 Number of cylinders..... 6
 Bore.....125 mm **4.9"**
 Stroke.....150 mm **5.9"**
 Piston displacement..... 11.04 ltr **674 in³**
 Governor.....All-speed, electronic
 Horsepower:
 SAE J1995..... Gross 204 kW **273 HP**
 ISO 9249 / SAE J1349..... Net 203 kW **272 HP**
 Rated rpm..... 2000 rpm
 Fan drive method for radiator cooling..... Hydraulic
 Fuel system.....Direct injection
 Lubrication system:
 Method.....Gear pump, force-lubrication
 Filter.....Full-flow type
 Air cleaner..... Dry type with double elements and dust evacuator, plus dust indicator

*EPA Tier 4 Final emissions certified



TRANSMISSION

Torque converter..... 3-elements, 1-stage, 2-phase
 Transmission.....Automatic full-powershift, countershaft type

Travel speed	Forward*	Reverse*
1st	7.6 km/h 4.7 mph	7.9 km/h 4.9 mph
2nd	13.1 km/h 8.1 mph (13.2 km/h 8.2 mph)	13.5 km/h 8.4 mph (13.7 km/h 8.5 mph)
3rd	22.9 km/h 14.2 mph (23.6 km/h 14.7 mph)	23.6 km/h 14.7 mph (24.3 km/h 15.1 mph)
4th	36.2 km/h 22.5 mph (38.3 km/h 23.8 mph)	37.3 km/h 23.2 mph (39.0 km/h 24.2 mph)

*P-mode Measured with 26.5-R25 tires (): Lock-up clutch ON



AXLES AND FINAL DRIVES

Drive system..... Four-wheel drive
 Front..... Fixed, semi-floating
 Rear..... Center-pin support, semi-floating,
 26° total oscillation
 Reduction gear..... Spiral bevel gear
 Differential gear..... Conventional type
 Final reduction gear..... Planetary gear, single reduction



BRAKES

Service brakes..... Hydraulically actuated,
 wet disc brakes actuate on four wheels
 Parking brake..... Wet disc brake
 Emergency brake..... Parking brake is commonly used



STEERING SYSTEM

Type..... Articulated type, fully-hydraulic power steering
 Steering angle..... 35° each direction (40° to max end stop)
 Minimum turning radius at
 the center of outside tire..... 6630 mm **21' 9"**



HYDRAULIC SYSTEM

Steering system:
 Hydraulic pump..... Piston type
 Capacity..... 195 ltr/min **51.5 U.S. gal/min** at rated rpm
 Relief valve setting..... 24.5 MPa 250 kgf/cm² **3,555 psi**
 Hydraulic cylinders:
 Type..... Double-acting, piston type
 Number of cylinders..... 2
 Bore x stroke..... .90 mm x 441 mm **3.5" x 17.3"**

Loader control:
 Hydraulic pump..... Piston pump
 Capacity..... .260 ltr/min **68.7 U.S gal/min** at rated rpm
 Relief valve setting..... 34.3 MPa 350 kgf/cm² **4,980 psi**
 Hydraulic cylinders:
 Type..... Double-acting, piston type
 Number of cylinders—bore x stroke:
 Lift cylinder..... .2- 140 mm x 764 mm **5.5" x 30.0"**
 Bucket cylinder..... .1- 160 mm x 575 mm **6.3" x 22.6"**
 Control valve..... 2-spool type
 Control positions:
 Boom..... Raise, hold, lower, and float
 Bucket..... Tilt-back, hold, and dump
 Hydraulic cycle time (rated load in bucket)
 Raise..... 5.8 s
 Dump..... 1.6 s
 Lower (Empty)..... 3.1 s



SERVICE REFILL CAPACITIES

Cooling system..... 78 ltr **20.6 U.S. gal**
 Fuel tank..... 380 ltr **100.4 U.S. gal**
 Engine..... 38 ltr **10.0 U.S. gal**
 Hydraulic system..... 173 ltr **45.7 U.S. gal**
 Axle front..... 57 ltr **15.1 U.S. gal**
 Axle rear..... 56 ltr **14.8 U.S. gal**
 Torque converter and transmission..... 65 ltr **17.2 U.S. gal**
 DEF tank..... 36 ltr **9.5 U.S. gal**



BUCKET SELECTION GUIDE

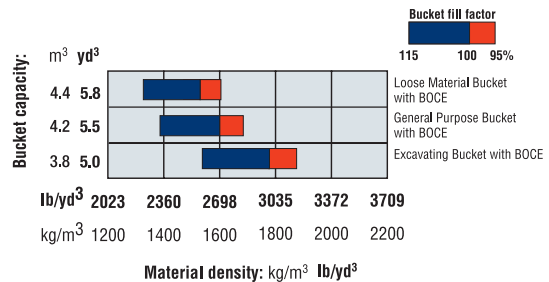

WA470-8



DIMENSIONS

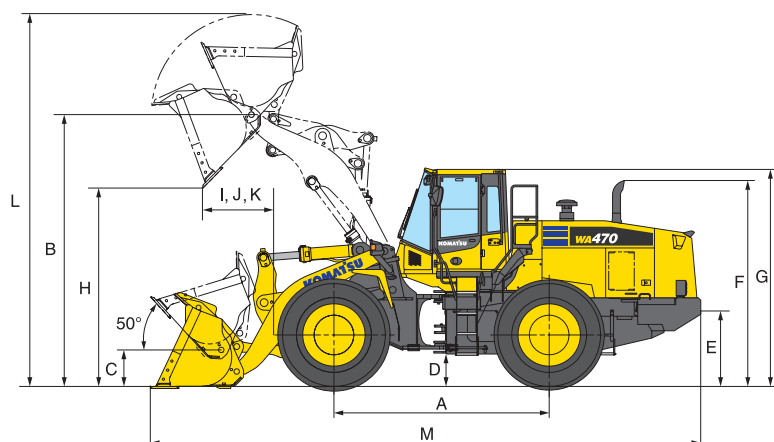

Tread	2300 mm	7'7"
Width over tires	3010 mm	9'11"
A Wheelbase	3450 mm	11'4"
B Hinge pin height,	Standard Boom 4360 mm	14'4"
max. height	High Lift Boom 4870 mm	16'0"
C Hinge pin height,	Standard Boom 585 mm	1'11"
carry position	High Lift Boom 730 mm	2'5"
D Ground clearance	525 mm	1'9"
E Hitch height	1210 mm	4'0"
F Overall height, top of the stack	3220 mm	10'7"
G Overall height, ROPS cab	3500 mm	11'6"

Measured with 26.5-R25 (L3) tires, ROPS/FOPS cab

	Standard Boom			High Lift Boom
	General Purpose Bucket	Excavating Bucket	Loose Material Bucket	Excavating Bucket
	Bolt-on Cutting Edge	Bolt-on Cutting Edge	Bolt-on Cutting Edge	Bolt-on Cutting Edge
Bucket capacity: heaped	4.2 m ³ 5.5 yd³	3.8 m ³ 5.0 yd³	4.4 m ³ 5.8 yd³	3.8 m ³ 5.0 yd³
struck	3.5 m ³ 4.6 yd³	3.2 m ³ 4.2 yd³	3.9 m ³ 5.1 yd³	3.2 m ³ 4.2 yd³
Bucket width	3170 mm 10'5"	3170 mm 10'5"	3170 mm 10'5"	3170 mm 10'5"
Bucket weight	2020 kg 4,453 lb	2170 kg 4,784 lb	2210 kg 4,872 lb	2170 kg 4,784 lb
H Dumping clearance, max. height and 45° dump angle*	3185 mm 10'5"	3235 mm 10'7"	3055 mm 10'0"	3750 mm 12'4"
I Reach at max. height and 45° dump angle*	1235 mm 4'1"	1185 mm 3'11"	1365 mm 4'6"	1330 mm 4'4"
J Reach at 2130 mm 7' clearance and 45° dump angle*	1935 mm 6'4"	1905 mm 6'3"	2010 mm 6'7"	2410 mm 7'11"
K Reach with arm horizontal and bucket level*	2755 mm 9'0"	2685 mm 8'10"	2940 mm 9'8"	2960 mm 9'9"
L Operating height (fully raised)	5960 mm 19'7"	5910 mm 19'5"	5960 mm 19'7"	6415 mm 21'1"
M Overall length (bucket on ground)	9075 mm 29'9"	9005 mm 29'7"	9260 mm 30'5"	9430 mm 30'11"
Loader clearance circle (bucket at carry, outside corner of bucket)	15300 mm 50'2"	15260 mm 50'1"	15390 mm 50'6"	15780 mm 51'9"
Digging depth: 0°	80 mm 3.2"	80 mm 3.2"	80 mm 3.2"	215 mm 8.5"
10°	315 mm 1'0"	305 mm 1'0"	345 mm 1'2"	440 mm 1'5"
Static tipping load: straight	20270 kg 44,688 lb	20130 kg 44,379 lb	20090 kg 44,291 lb	16500 kg 36,376 lb
40° full turn	17460 kg 38,493 lb	17320 kg 38,184 lb	17280 kg 38,096 lb	14050 kg 30,975 lb
Breakout force	192 kN 19600 kgf 43,163 lb	203 kN 20710 kgf 45,636 lb	168 kN 17140 kgf 37,768 lb	186 kN 19018 kgf 41,927 lb
Operating weight	24200 kg 53,352 lb	24350 kg 53,683 lb	24390 kg 53,771 lb	25210 kg 55,579 lb

* At the end of tooth or B.O.C.E.

All dimensions, weights, and performance values based on SAE J732c and J742b standards.

Static tipping load and operating weight shown include lubricant, coolant, full fuel tank, ROPS cab, and operator.

Machine stability and operating weight affected by counterweight, tire size, and other attachments.

Apply the following weight changes to operating weight and static tipping load.



WEIGHT CHANGES

Tires or attachments	Operating weight		Tipping load straight		Tipping load full turn	
	kg	lb	kg	lb	kg	lb
Remove additional counterweight	-400	-882	-1300	-2866	-1100	-2425



STANDARD EQUIPMENT

- 2-spool valve for boom and bucket control
- Alternator, 90 A
- Auto shift transmission with mode select system
- Automatic hydraulic-driven fan with automatic reverse rotation
- Back-up alarm
- Batteries, 140 Ah/12V (2), 930 CCA
- Battery disconnect
- Boom Kick-out, in-cab adjustable
- Bucket Positioner, in-cab adjustable, 3 positions
- Color rear view camera and monitor
- Counterweight, standard and additional
- Electronically Controlled Suspension System (ECSS)
- Engine, Komatsu SAA6D125E-7 diesel
- Engine shut-off system, electric
- EPC fingertip controls with F-N-R switch, two levers
- Equipment Management Monitoring System (EMMS)
 - Lights (central warning, brake oil pressure, engine oil pressure, parking brake, cooling fan reverse, KDPF restriction, seat belt caution, Komtrax message)
- Gauges (Engine water temperature, ecology, fuel level, DEF level, hydraulic oil temperature, speedometer/tachometer)
 - Front fenders
 - Fuel pre-filter with water separator
 - Horn, electric
 - Komatsu SmartLoader Logic
 - Komatsu Auto Idle Shutdown
 - KOMTRAX® Level 5
 - Lift cylinders and bucket cylinder
 - Lights
 - Back-up light, LED
 - Stop and tail light, LED
 - Turn signal lamps, 2 front and 2 rear with hazard switch
 - Working lights, halogen, 2 front cab mount
 - Working lights, halogen, 2 front fender mount
 - Working lights, halogen, 2 rear grill mount
 - Loader linkage with standard lift arm
 - Lock-up torque converter
 - Parking brake, electric
 - Radiator, wider core
 - Radiator mask, swing out
 - Rear full fenders
 - Rear view mirrors, outside (2) inside (2)
 - Rims for 26.5-25 tires
- ROPS/FOPS Cab Level 2
 - 2 x DC12V electrical outlets
 - Ashtray
 - Auto air conditioner
 - Cigarette lighter, 24V
 - Color LCD/TFT multi-monitor
 - Cup holder
 - Floor mat
 - Operator seat, reclining, air suspension type, heated
 - Radio, AM/FM with AUX input jack
 - Rear defroster, electric
 - Seatbelt, 2-point retractable, 76mm 3" width
 - Space for Lunch box
 - Steering wheel, tilt and telescopic
 - Sun visor, front window
 - Windshield washer and wiper, front with intermittent
 - Windshield washer and wiper, rear
- Service brakes, wet disc type
- Starting motor, 7.5 kW
- Transmission, 4 forward and 4 reverse
- Vandalism protection kit, padlocks for battery box (2)



OPTIONAL EQUIPMENT

- 3-spool valve with lever and piping
- Auxiliary steering (SAE)
- Cutting edge (bolt-on type)
- Engine pre-cleaner with extension
- High-lift boom
- Joystick/wheel steering control system
- Limited slip differential (F&R)
- Monolever loader control with transmission F-N-R switch
- Various tire options, radial and bias
- Various bucket options



Note: All comparisons and claims of improved performance made herein are made with respect to the prior Komatsu model unless otherwise specifically stated.