

KOMATSU®

WA480-8

Tier 4 Final Engine

WHEEL LOADER

WA480



Photos may include optional equipment.

NET HORSEPOWER

299 HP @ 2000 rpm
223 kW @ 2000 rpm

OPERATING WEIGHT

57,232 lb – 61,311 lb
25960 kg – 27810 kg

BUCKET CAPACITY

6.0 – 7.2 yd³
4.6 – 5.5 m³

WALK-AROUND

WA480-8



Photos may include optional equipment.

NET HORSEPOWER
299 HP @ 2000 rpm
223 kW @ 2000 rpm

OPERATING WEIGHT
57,232 lb – 61,311 lb
25960 kg – 27810 kg

BUCKET CAPACITY
6.0 – 7.2 yd³
4.6 – 5.5 m³



PERFORMANCE, DURABILITY AND FUEL ECONOMY

Large capacity torque converter with lock-up:

- Quick acceleration
- Lock-up in 2nd, 3rd and 4th gear

Komatsu SmartLoader Logic helps reduce fuel consumption with no decrease in production.



The **Yard Loader arrangement** features a 7.2 yd³ genuine Komatsu high performance bucket, low profile 775/65/ R29 tires, an improved brake cooling system and a heavier Yard Loader counter weight, and is designed to three pass typical on-highway trucks.

A powerful **Komatsu SAA6D125E-7 engine** provides a net output of 223 kW **299 HP** with up to 20% improved fuel consumption.* This engine is EPA Tier 4 Final emissions certified.

Variable Geometry Turbocharger (VGT) uses a hydraulic actuator to provide optimum air flow under all speed and load conditions.

Komatsu Diesel Particulate Filter (KDPF) and Selective Catalytic Reduction (SCR) systems reduce particulate matter and NOx while providing automatic regeneration that does not interfere with daily operation.

Fluid neutral or better

Fuel & DEF total consumption is less than fuel consumed by the prior model.

Cooling

- Hydraulically driven, variable speed
- Auto-reversing fan is standard
- Wider core coolers resist clogging
- Swing out fan for easy cleaning

Remote boom and bucket positioners can set kick-outs from inside the cab.

Variable displacement piston pumps with CLSS provides quick response and smooth operation to maximize productivity.

Rearview monitoring system (standard)

Advanced diagnostic system continuously monitors machine operation and vital systems to identify machine issues and assist with troubleshooting.

Transmission Mode Select System (3 modes) allows shifting mode to be matched more efficiently to varying work applications.

Enhanced working environment:

- High capacity air suspension seat, heated
- Seat mounted EPC controls with F-N-R switch
- (2) 12V power outlets

New style of front fender is plastic for durability.

Rear full fenders (standard) are made of durable plastic and swing open for easy access to maintenance points.

Large LCD color monitor panel:

- 7" high resolution, multi-color screen is easy to read
- Provides "Ecology Guidance" for fuel efficient operation
- Onboard diagnostics do not require use of a laptop computer
- Multiple choice, pull-down menus are filled with useful functions

Komatsu Auto Idle Shutdown helps reduce idle time and operating costs.

External mounting of engine air filter (above rear LH fender) provides easy access for maintenance.

The **KOMTRAX®** telematics system is standard on Komatsu equipment with no subscription fees throughout the life of the machine. Using wire-less technology, **KOMTRAX®** transmits valuable information such as location, utilization, and maintenance records to a PC or smartphone app. Custom machine reports are provided for identifying machine efficiency and operating trends. **KOMTRAX®** also provides advanced machine troubleshooting capabilities by continuously monitoring machine health.

Battery disconnect switch allows a technician to disconnect and lock-out the power supply before servicing the machine.

Operator Identification System can track machine operation for up to 100 operators.

*Compared to the WA480-6.

PERFORMANCE FEATURES

KOMATSU NEW ENGINE TECHNOLOGIES

New Tier 4 Final Engine

The Komatsu SAA6D125E-7 engine is EPA Tier 4 Final emissions certified and provides exceptional performance while reducing fuel consumption. Based on Komatsu proprietary technologies developed over many years, this new diesel engine reduces nitrogen oxides (NOx) by more than 80% when compared to Tier 4 interim levels.

Technologies Applied to New Engine

Heavy-duty aftertreatment system

This new system combines a Komatsu Diesel Particulate Filter (KDPF) and Selective Catalytic Reduction (SCR). The SCR NOx reduction system injects the correct amount of Diesel Exhaust Fluid (DEF) at the proper rate, thereby decomposing NOx into non-toxic water vapor (H₂O) and nitrogen gas (N₂).

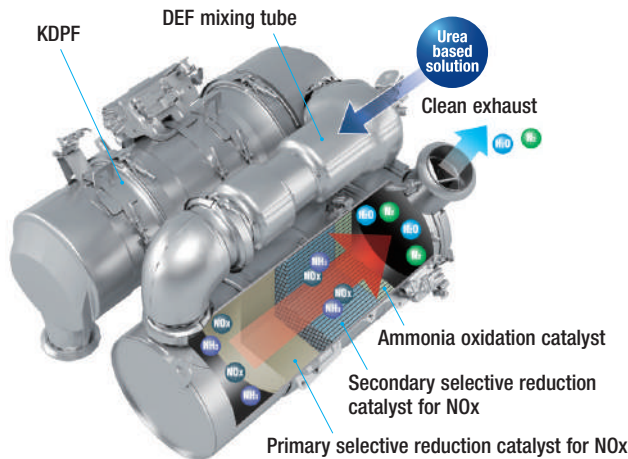

Heavy-duty cooled Exhaust Gas Recirculation (EGR) system

The system recirculates a portion of exhaust gas into the air intake and lowers combustion temperatures, thereby reducing NOx emissions. EGR gas flow has been decreased for Tier 4 Final with the addition of SCR technology. The system dramatically reduces NOx, while helping cut fuel consumption below Tier 4 Interim levels.

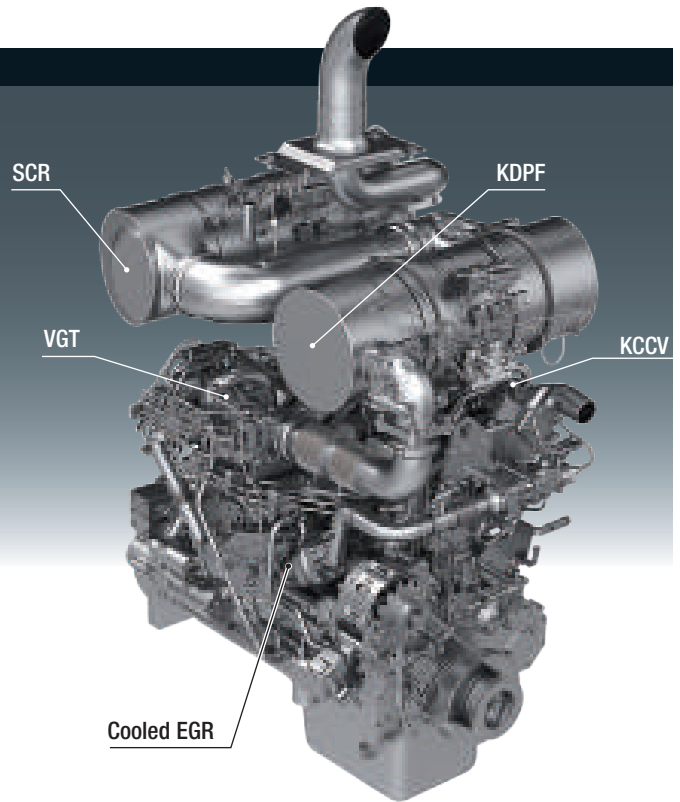
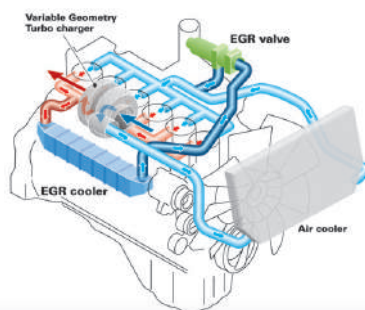

Advanced Electronic Control System

The electronic control system performs high-speed processing of all signals from sensors installed in the vehicle providing total control of equipment. Engine condition information is displayed on the monitor inside the cab, providing necessary information to the operator. Additionally, managing the information via KOMTRAX helps customers keep up with required maintenance.

Variable Geometry Turbocharger (VGT) system

The VGT system features proven Komatsu design hydraulic technology for variable control of air-flow and supplies optimal air according to load conditions. The upgraded version provides better exhaust temperature management.

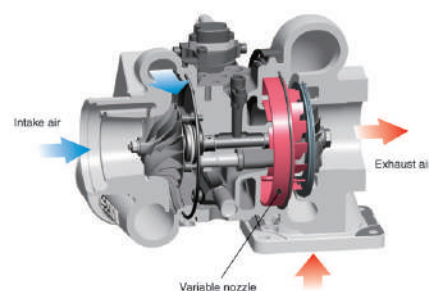

Heavy-duty High-Pressure Common Rail (HPCR) fuel injection system

The system is designed to achieve an optimal injection of high-pressure fuel digitally, thereby bringing near complete combustion to reduce PM emissions.

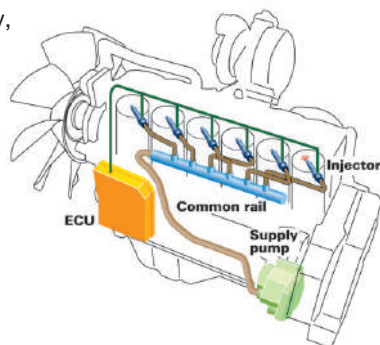

Komatsu SmartLoader Logic

The WA480-8 provides Komatsu SmartLoader Logic, an engine control system. This technology creates enough torque for each work phase. For example, engine torque needs are higher for digging in V-shape loading, but less when driving with an empty bucket. This system optimizes the engine torque for all applications to minimize fuel consumption. Komatsu SmartLoader Logic functions automatically and doesn't interfere with operation, saving fuel without decreasing production.

Large-capacity Torque Converter

The Komatsu designed power train has a large capacity torque converter for optimum efficiency. The WA480-8 has greater productivity in V-shape loading applications because the increased tractive effort does not require full throttle. The improved hill climbing ability allows the WA480-8 to up-shift gears faster because of improved acceleration. The WA480-8 can achieve higher gear ranges and maintain higher travel speed when working in load-and-carry applications. In most applications, production is increased and fuel consumption is reduced, resulting in improved fuel efficiency.

Enhanced Lock-up

The Komatsu designed torque converter with lock-up is standard on the WA480-8. The lock-up function activates in 2nd, 3rd and 4th gears. The lock-up torque converter is effective for both load and carry application and V-shape loading which uses lower gears. Komatsu SmartLoader Logic reduces the clutch engagement shock of lock-up by controlling engine torque. The lock-up torque converter combined with Komatsu SmartLoader Logic results in low fuel consumption and high travel speeds in load and carry and even some V-cycle loading applications.

Engine Power Select System

This wheel loader offers three selectable operating modes – E, P, and E-light.

- E Mode: This mode provides maximum fuel efficiency for general loading.
- P Mode: This mode provides maximum power output for hard digging operation or hill climbing.



- 1 Dual mode engine power selection switch
- 2 Transmission shift mode selector switch
- 3 Torque converter lock-up switch
- 4 Automatic digging ON/OFF switch

New E-light Mode is activated in the monitor panel for the lowest possible fuel consumption. When activated, the engine matches power to the working conditions, for higher fuel efficiency. The work equipment and steering pumps are electronically controlled to prevent waste and deliver the exact amount required.

Automatic Transmission with Mode Select System

This operator controlled system allows the operator to select manual shifting or two levels of automatic shifting (low, and high). Auto L mode is for fuel saving operation with the gear shift timing set at lower speeds than Auto H mode. Therefore Auto L mode keeps the engine in a relatively low rpm range for fuel conservation while yielding required tractive force by operator depressing the accelerator pedal.

Variable Displacement Piston Pump & CLSS

The variable displacement piston pump combined with the Closed-center Load Sensing System (CLSS) delivers hydraulic flow just as the job requires preventing wasted hydraulic flow. Minimized loss contributes to better fuel economy.

Komatsu Auto Idle Shutdown

In order to reduce idle time, Komatsu offers Komatsu Auto Idle Shutdown. This function will shut the engine off and apply the parking brake and hydraulic lock after a preset idle time limit. This time limit can be set by the operator or service technician and may range from 3 minutes to 60 minutes.

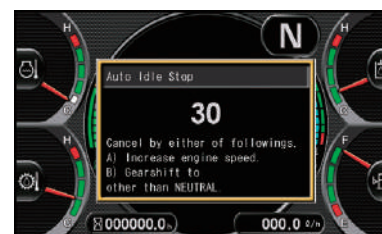

OPERATOR ENVIRONMENT



New Operator Seat with Electronic Pilot Control (EPC) Levers

A new air suspension seat provides enhanced support on rough roads and dampens machine vibrations, providing a more comfortable ride for the operator. An EPC lever console is integrated in the seat and moves with the seat. The angle of the armrest is fully adjustable for optimum operator comfort. A secondary F-N-R switch is incorporated in work equipment lever configurations. A heated seat is standard.



Tiltable / Telescopic Steering Wheel

The operator can both tilt and telescope the steering wheel to allow maximum comfort and control. The two spoke steering wheel allows maximum visibility of the monitor panel and the forward work environment.



Low Noise Design

Operator's ear noise level : 72 dB(A)*
Dynamic noise level (outside): 112 dB(A)**

The large cab is mounted with Komatsu's unique ROPS/FOPS viscous mounts. The low-noise engine, hydraulically driven fan, and hydraulic pumps are mounted with rubber cushions, and the cab sealing is improved to provide a quiet, low-vibration, dust-proof, and comfortable operating environment.

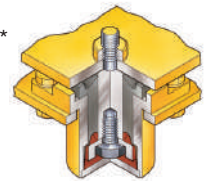

* ISO 6396: 2008
** ISO 6395: 2008

Mono-lever with Integrated 3rd Spool Control (Optional)

The mono-lever allows the operator to control the optional 3rd spool with your thumb which greatly increases ease of operation. The 3rd spool valve can be operated in either continuous or proportional flow modes. The mono-lever also includes a F-N-R switch.



Rear View Monitoring System (standard)

The operator can view the rear of the machine with a full color monitor that is located on the right side of the cab. This monitor can be always on or only on when the loader goes into reverse. Visual guidelines can also be added for more convenience.



Engine Shutdown Secondary Switch

The engine stop switch is incorporated to allow shutdown of the machine when accessing the key switch is not possible.

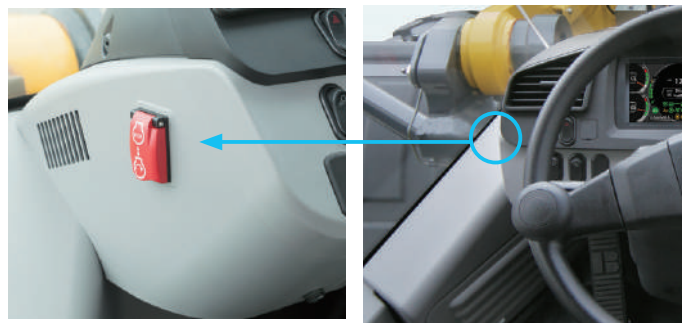

Auxiliary Input (MP3 Jack) 12 V Outlets

An Aux input for digital devices is standard as well as two 12 volt outlets. These are all located on the front of the right hand console.

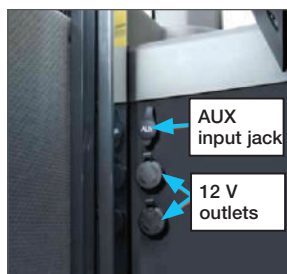

WORKING ENVIRONMENT



Easy Entry and Egress

The WA480-8 has an inclined ladder with wide steps and hand holds to ease entry and exit from the cab.

Remote Bucket & Boom Positioner

The operator can set the bucket angle and remote boom positioner from the cab. Both upper and lower boom positions are adjustable in the cab with the push of a button. The bucket positioner can memorize three horizontal settings, allowing the operator to easily change attachments without having to reset the bucket position. In each horizontal setting, the operator can adjust the setting with the switch in the cab. This can help save the operator time when changing attachments.



Remote positioner switch
Boom / Bucket

Automatic Kick-down

The WA480-8 has the ability to automatically shift down to F1. This can be activated through the monitor.

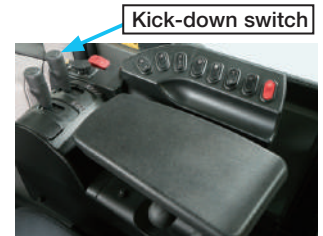

Electronically Controlled Suspension System

The Electronically Controlled Suspension System (ECSS) or ride control system uses an accumulator which minimizes boom arm shock, giving the operator a much smoother ride. This reduces operator fatigue and reduces material spillage during load and carry operations. ECSS is speed sensitive, meaning that the boom won't move during stationary digging. ECSS is standard on the WA480-8.

Advanced Joystick Steering System (AJSS) (option)

Allows steering and directional travel to be controlled by wrist and finger control to minimize operator fatigue in high duty cycle applications. AJSS allows for full speed travel speed while maintaining precise steering and control.

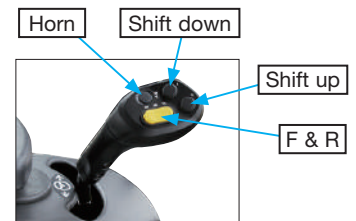

New Bucket Design

The newly designed bucket improves overall machine productivity. Generous curves on the side wall and wrap improve pile penetration and make it easy to fill. They also improve material retention in carry operations.

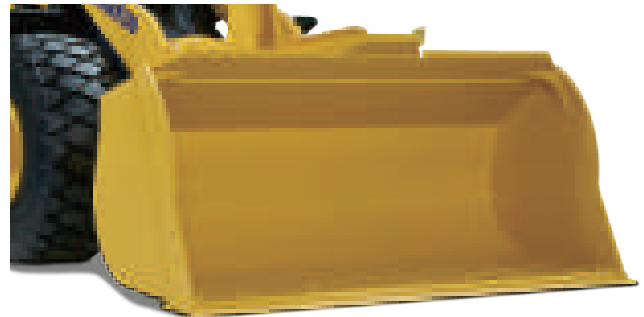

High Resolution 7-inch Color LCD Monitor

The machine monitor display various machine information and allows for various settings of the machine. The LCD monitor is a 7-inch color TFT-LCD and displays maintenance information, operation record, Ecology Guidance record, and other machine data. The switch panel is used to select various screens and the air conditioner control screen. By using the switch panel, you can display various user menus on the LCD screen and adjust the machine settings.

Machine monitor

- | | |
|---------------------------|---|
| 1 LCD unit | 8 Engine coolant temperature gauge |
| 2 LED unit | 9 Hydraulic oil temperature gauge |
| 3 Engine tachometer | 10 Torque converter oil temperature gauge |
| 4 Speedometer | 11 Fuel gauge |
| 5 Ecology gauge | 12 Message pilot lamp |
| 6 Air conditioner display | 13 Pilot lamps |
| 7 Shift indicator | 14 DEF level gauge |

Switch panel

- | | |
|--|---------------------|
| 1 Air conditioner switches / Numeral key pad | 2 Function switches |
|--|---------------------|



Visual user menu

Pressing the menu switch on the switch panel displays the user menu screen. The menus are grouped for each function, and use easy-to-understand icons which enable the machine to be operated intuitively.

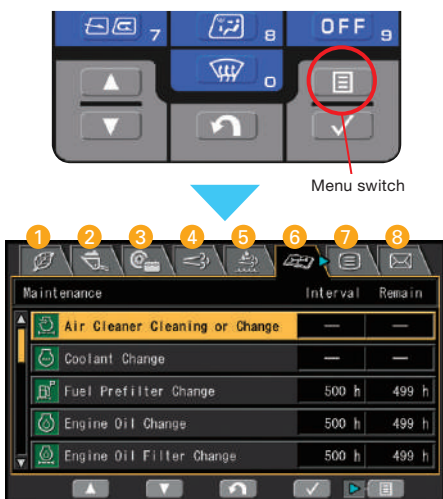

- 1 Energy saving guidance
- 2 Load meter setting (optional)
- 3 Machine settings
- 4 Aftertreatment devices regeneration
- 5 SCR information
- 6 Maintenance
- 7 Monitor setting
- 8 Mail check

Operator identification function

An operator identification (ID) can be set for each operator, and used to manage operation information of individual machines as KOMTRAX data. Data sent from KOMTRAX can be used to analyze operation status by operator as well as by machine.



Machine monitor with troubleshooting function to minimize downtime

Various meters, gauges and warning functions are centrally arranged on the machine monitor. The monitor simplifies start-up inspection and promptly warns the operator with a lamp and buzzer if any abnormalities should occur. In addition, countermeasures are indicated in 4 levels to ensure safety and help prevent the machine from having major problems. Replacement times for oil and filters are also indicated.



MAINTENANCE FEATURES



WA480-8

Side-opening Gull-wing Engine Doors

The large gull-wing type engine doors require less effort to open and close thanks to gas assisted struts. The doors provide wide areas of access for ease of daily maintenance. Large steps on each side of the frame enhance accessibility.



Easy access Wide Core Radiator

The door swings open for easy cleaning. The coolers feature wide spacing of the cooling fins to reduce clogging.



Auto Reversing Fan

The engine cooling fan is driven hydraulically. It can be set to reverse automatically during operation. Fan reverse mode and timing can be controlled through the monitor.

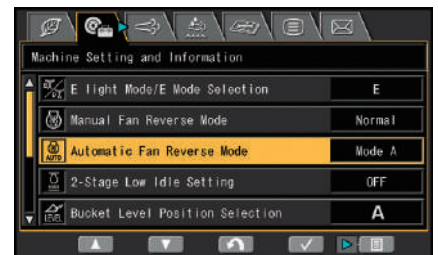

DEF Tank

The DEF tank is located on the right hand side of the machine behind a ladder for easy access. An external sight gauge aids in preventing overflow and spillage while refilling. A new magnetized holder is provided for added convenience.



Battery Disconnect Switch

The battery disconnect switch is located in the right side of the engine. This can be used to disconnect power when performing service work on the machine. The switch can also be locked out using a personal lock or hasp.



Engine Compartment

The WA480-8 engine compartment is designed for easy serviceability. Placement of maintenance items, such as filters, dipsticks, oil fill locations, and aftertreatment devices is all very intuitive.

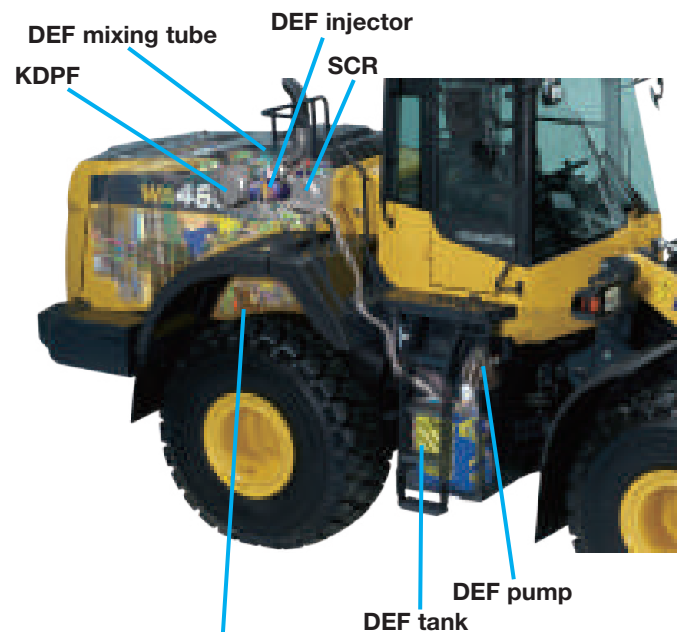

Engine oil fill Fuel filter Oil filter
 Engine oil dipstick Fuel pre-filter

Rear Full Fenders (Standard)

The WA480-8 has a rear full fender standard. The plastic rear fenders open outward, keeping the force to open the engine doors low, even when there is mud or snow on the fenders. The fenders swing far out of the way to give the technician easy access to the engine compartment. Mudflaps are also included on the rear fenders.



Air Conditioner Filter

The inside and outside air conditioner filters can be replaced easily without using a tool. The outside filter is located behind a lockable door for security.



Inside air filter

Outside air filter

LED Taillights

LED brake lights and LED reverse lights provide long bulb life.



Air Cleaner

The air cleaner is located on the left side platform for easy access.



Maintenance Information

“Maintenance time caution lamp” display

When the remaining time to maintenance becomes less than 30 hours*, the maintenance time monitor appears. Pressing the menu switch displays the maintenance screen.

* : The setting can be changed within the range between 10 and 200 hours.

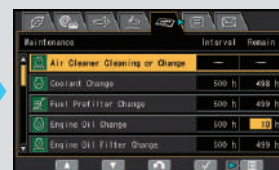

Maintenance screen

Supports the DEF level and refill timing

The DEF level gauge is displayed continuously on the monitor screen. In addition, when the refill timing is reached, the DEF low level guidance appears as a pop up display to inform the operator in real time.



DEF level gauge



DEF low level guidance

KOMATSU PARTS & SERVICE SUPPORT



KOMATSU CARE Program Includes:

*The WA480-8 comes standard with complimentary factory scheduled maintenance for the first 3 Years or 2,000 Hours, whichever comes first.

Planned Maintenance Intervals at:

500/1000/1500/2000 hour intervals. (250 hr. initial interval for some products) Complimentary Maintenance Interval includes: Replacement of Oils & Fluid Filters with genuine Komatsu Parts, 50-Point inspection, Komatsu Oil & Wear Analysis Sampling (KOWA) / Travel & Mileage (distance set by distributor; additional charges may apply)

Benefits of Using Komatsu CARE

- Assurance of Proper Maintenance with OEM Parts & Service
- Increased Uptime & Efficiency
- Factory Certified Technicians Performing Work
- Cost of Ownership Savings
- Transferable Upon Resale

Complimentary KDPF Exchanges

The WA480-8 comes standard with 2 Complimentary KDPF Exchange units for the first 5 Years or 9000 hours whichever comes first. The suggested KDPF Exchange unit service intervals are 4500 hours & 9000 hours. End user must have authorized Komatsu distributor perform the removal & installation of the KDPF.

Complimentary SCR Maintenance

The WA480-8 also includes 2 factory recommended services of the Selective Catalytic Reduction (SCR) Diesel Exhaust Fluid (DEF) system during the first 5 Years or 9000 hours whichever comes first. The service includes factory recommended DEF tank flush & strainer cleaning at the suggested service intervals of 4500 hours & 9000 hours.

Interval PM	i250	500	1000	1500	2000
PERFORM KOWA SAMPLING (5 samples) – engine, transmission, hydraulics, front & rear axle	✓	✓	✓	✓	✓
CLEAN AC FRESH AND RECIRC AIR FILTERS	✓				
REPLACE HYDRAULIC OIL FILTER ELEMENT	✓				✓
REPLACE TRANSMISSION OIL FILTER	✓		✓		✓
CHECK AND CLEAN AIR CLEANER	✓	✓	✓	✓	✓
CHECK AND CLEAN FUEL BREATHER ELEMENT	✓	✓	✓	✓	✓
LUBRICATE REAR AXLE PIVOT PIN	✓	✓	✓	✓	✓
LUBRICATE WORK EQUIPMENT	✓	✓	✓	✓	✓
CHECK PARKING BRAKE	✓	✓	✓	✓	✓
CHECK WHEEL HUB BOLTS AND RETIGHTEN AS NECESSARY	✓	✓	✓	✓	✓
DRAIN SEDIMENT FROM FUEL TANK	✓	✓	✓	✓	✓
COMPLETE 50 POINT INSPECTION FORM; LEAVE PINK COPY WITH CUSTOMER OR IN CAB	✓	✓	✓	✓	✓
RESET MONITOR PANEL MAINTENANCE COUNTER FOR APPROPRIATE ITEMS	✓	✓	✓	✓	✓
CHANGE ENGINE OIL		✓	✓	✓	✓
REPLACE ENGINE OIL FILTER		✓	✓	✓	✓
REPLACE AC FRESH & RECIRC AIR FILTERS		✓	✓	✓	✓
REPLACE FUEL PRE-FILTER		✓	✓	✓	✓
REPLACE FUEL MAIN FILTER			✓		✓
REPLACE DEF TANK BREATHER			✓		✓
CLEAN TRANSMISSION BREATHER ELEMENT			✓		✓
REPLACE TRANSMISSION OIL STRAINER			✓		✓
LUBRICATE CENTER HINGE PIN			✓		✓
LUBRICATE DRIVE SHAFT CENTER SUPPORT					✓
CHANGE TRANSMISSION OIL					✓
CHANGE FRONT AND REAR AXLE OIL					✓
REPLACE HYDRAULIC TANK BREATHER ELEMENT					✓
CLEAN HYDRAULIC OIL STRAINER					✓
CHANGE HYDRAULIC OIL					✓
REPLACE DEF PUMP FILTER					✓
REPLACE KCCV FILTER					✓
FACTORY TRAINED TECHNICIAN LABOR	✓	✓	✓	✓	✓
2 KDPF Exchanges at 4,500 Hrs and 9,000 Hrs.					
2 SCR System Maintenance Services at 4,500 Hrs. and 9000 Hrs.					

Komatsu CARE® – Extended Coverage

- Extended Coverage can provide peace of mind by protecting customers from unplanned expenses that effect cash flow
- Purchasing extended coverage locks-in the cost of covered parts and labor for the coverage period and helps turn these into fixed costs



Komatsu Parts Support

- 24/7/365 to fulfill your parts needs
- 9 parts Distribution Centers strategically located across the U.S. and Canada
- Distributor network of more than 300 locations across U.S. and Canada to serve you
- Online part ordering through Komatsu eParts
- Remanufactured components with same-as-new warranties at a significant cost reduction



Komatsu Oil and Wear Analysis (KOWA)

- KOWA detects fuel dilution, coolant leaks, and measures wear metals
- Proactively maintain your equipment
- Maximize availability and performance
- Can identify potential problems before they lead to major repairs
- Reduce life cycle cost by extending component life

* Certain exclusions and limitations apply. Refer to the customer certificate for complete program details and eligibility.

WA480-8

KOMTRAX EQUIPMENT MONITORING

GET THE WHOLE STORY WITH
KOMTRAX[®]

✓ **WHAT**

- KOMTRAX is Komatsu's remote equipment monitoring and management system
- KOMTRAX **continuously monitors and records** machine health and operational data
- Information such as fuel consumption, utilization, and a detailed history **lowering owning and operating cost**

✓ **WHEN**

- Know when your machines are **running or idling** and make decisions that will improve your fleet utilization
- Detailed movement records ensure you know when and where your equipment is moved
- Up to date records allow you to **know when maintenance is due** and help you plan for future maintenance needs

✓ **WHERE**

- KOMTRAX data **can be accessed virtually anywhere** through your computer, the web or your smart phone
- Automatic alerts keep fleet managers up to date on the latest machine notifications

✓ **WHO**

- KOMTRAX is **standard** equipment on all Komatsu construction products



✓ **WHY**

- Knowledge is power - **make informed decisions** to manage your fleet better
- Knowing your idle time and fuel consumption will help maximize your machine efficiency
- **Take control of your equipment** - any time, anywhere



KOMTRAX[®]

For construction and compact equipment.

KOMTRAX Plus[®]

For production and mining class machines.



DIMENSIONS

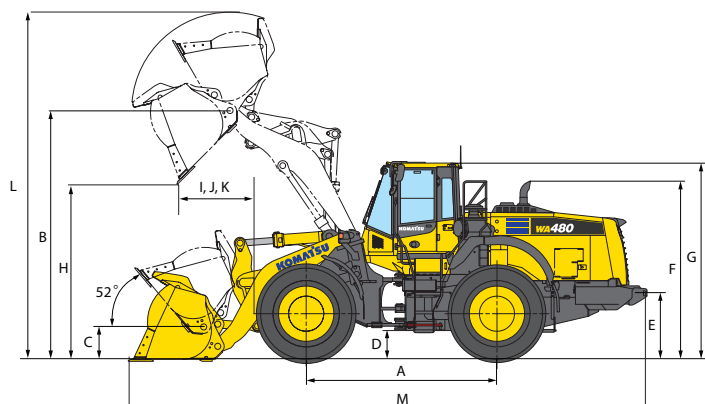

Tread	Standard Loader	2300 mm	7'7"
	Yard Loader	2314 mm	7'7"
Width over standard tires	Standard Loader	3010 mm	10'
Width over 775/65R29 tires	Yard Loader	3150 mm	10'4"
A Wheelbase		3450 mm	11'4"
B Hinge pin height, max. height		4505 mm	14'9"
C Hinge pin height, carry position		585 mm	1'11"
D Ground clearance		525 mm	1'8"
E Hitch height		1210 mm	4'
F Overall height, top of the stack		3220 mm	11'7"
G Overall height, ROPS cab		3575 mm	11'9"
F Overall height, top of air brake cooling	Yard Loader	3600 mm	11'10"

Measured with 26.5-R25(L3) Tires, ROPS/FOPS cab

	Standard Boom		
	General Purpose Bucket Pin On	Loose Material Bucket Pin On	Loose Material Bucket Pin On
	Bolt-on Cutting Edge	Bolt-on Cutting Edge	Bolt-on Cutting Edge
Bucket capacity: heaped	4.6 m ³ 6.0 yd³	5.0 m ³ 6.5 yd³	5.5 m ³ 7.2 yd³
struck	4.0 m ³ 5.2 yd³	4.3 m ³ 5.6 yd³	5.0 m ³ 6.5 yd³
Bucket width	3170 mm	3170 mm	3190 mm
*with bucket side guard	10'5"	10'5"	10'5"
Bucket weight	2387 kg 5262 lb	2458 kg 5419 lb	2608 5750 lb
H Dumping clearance, max. height and 45° dump angle*	3165 mm 10'5"	3095 mm 10'2"	3025 mm 9'11"
I Reach at max. height and 45° dump angle*	1440 mm 4'9"	1530 mm 5'0"	1600 mm 5' 3"
J Reach at 2130 mm 7' clearance and 45° dump angle*	2165 mm 7'1"	2205 mm 7'3"	2240 mm 7'4"
K Reach with arm horizontal and bucket level*	3080 mm 10'1"	3180 mm 10'2"	3274 mm 10'9"
L Operating height (fully raised)	6280 mm 20'7"	6375 mm 20'11"	6375 mm 20'11"
M Overall length (bucket on ground)	9375 mm 30'9"	9475 mm 31'1"	9575 mm 31'5"
Loader clearance circle (bucket at carry, outside corner of bucket)	15420 mm 50'7"	15475 mm 50'9"	15525 mm 50'11"
Digging depth: 0°	90 mm 3.5"	90 mm 3.5"	90 mm 3.5"
10°	365 mm 1'2"	385 mm 1'3"	400 mm 1'4"
Static tipping load: straight	20205 kg** 44,544 lb**	20100 kg** 44,313 lb**	21295 kg 46,947 lb
40° full turn	17540 kg** 38,669 lb**	17435 kg** 38,437 lb**	18345 kg 40,444 lb
Breakout force	206 kN 21000 kgf 46,297 lb	193 kN 19700 kgf 43,431 lb	182 kN 18530 kgf 40,915 lb
Operating weight	25960 kg** 57,232 lb**	26030 kg** 57,386 lb**	27810 kg 61,311 lb
Equipped with 775/65R29 tires	No	No	Yes

*At the end of tooth or B.O.C.E. (Bolt on cutting edge)

All dimensions, weights, and performance values based on ISO 7131, ISO 14397-1 and ISO 7546 standards.

Static tipping load and operating weight shown include lubricant, coolant, full fuel tank, ROPS cab, and operator. Machine stability and operating weight affected by counterweight, tire size, and other attachments.

**Effective from S/N A48081, 100438



WEIGHT AND DIMENSION CHANGES

Tires or attachments	Operating weight		Tipping load straight		Tipping load full turn		Width over tires		Ground clearance		Change in vertical dimensions	
	kg	lb	kg	lb	kg	lb	mm	in	mm	in	mm	in
26.5-25-20PR(L-4)	+340	+750	+239	+527	+211	+465	3010	119	525	21	0	0
Remove additional counterweight	-378	-833	-924	-2037	-769	-1695						



STANDARD EQUIPMENT

- 2-spool valve for boom and bucket control
- Alternator, 90 A
- Auto shift transmission with mode select system
- Automatic Digging System
- Automatic hydraulic-driven fan with automatic reverse rotation
- Back-up alarm
- Batteries, 140 Ah/12V (2), 930 CCA
- Battery disconnect with lockout
- Boom Kick-out, in-cab adjustable
- Bucket Positioner, in-cab adjustable, 3 positions
- Color rear view camera and monitor
- Counterweight, standard and additional
- Electronically Controlled Suspension System (ECSS)
- Engine, Komatsu SAA6D125E-7 diesel
- Engine shut-off system, electric
- EPC fingertip controls with F-N-R switch, two levers
- Equipment Management Monitoring System (EMMS)
 - Lights (central warning, brake oil pressure, engine oil pressure, parking brake, cooling fan reverse, KDPF restriction, seat belt caution, Komtrax message)
- Gauges (Engine water temperature, ecology, fuel level, DEF level, hydraulic oil temperature, speedometer/tachometer)
 - Front fenders
 - Fuel pre-filter with water separator
 - Horn, electric
 - Integrated Load Meter (2 lever only)
 - Komatsu SmartLoader Logic
 - Komatsu Auto Idle Shutdown
 - KOMTRAX® Level 5
 - Lift cylinders and bucket cylinder
 - Lights
 - Back-up light, LED
 - Stop and tail light, LED
 - Turn signal lamps, 2 front and 2 rear with hazard switch
 - Working lights, halogen, 2 front cab mount
 - Working lights, halogen, 2 front fender mount
 - Working lights, halogen, 2 rear grill mount
 - Loader linkage with standard lift arm
 - Lock-up torque converter
 - Parking brake, electric
 - Radiator, wider core
 - Radiator mask, swing out
 - Rear full fenders
 - Rear view mirrors, outside (2) inside (2)
 - Rims for 26.5-25 tires
- ROPS/FOPS Cab Level 2
 - 2 x DC12V electrical outlets
 - Ashtray
 - Auto air conditioner
 - Cigarette lighter, 24V
 - Color LCD/TFT multi-monitor
 - Cup holder
 - Floor mat
 - Operator seat, reclining, air suspension type, heated
 - Radio, AM/FM with AUX input jack
 - Rear defroster, electric
 - Seatbelt, 2-point retractable, 76mm 3" width
 - Space for Lunch box
 - Steering wheel, tilt and telescopic
 - Sun visor, front window
 - Windshield washer and wiper, front with intermittent
 - Windshield washer and wiper, rear
- Service brakes, wet disc type
- Starting motor, 7.5 kW
- Transmission, 4 forward and 4 reverse
- Vandalism protection kit, padlocks for battery box (2)



OPTIONAL EQUIPMENT

- Advanced Joystick Steering System (AJSS)
- Auto Lube System
- Auxiliary steering (SAE)
- Block heater and oil pan heater
- Cutting edge (bolt-on type)
- Engine pre-cleaner with extension
- Limited slip differential (F&R)
- Load Meter Printer (2 lever only)
- Monolever loader control with transmission F-N-R switch (not compatible with AJSS)
- Various tire options, radial and bias
- Various bucket options

AESS930-03

© 2021 Komatsu Ltd. or one of its subsidiaries. All rights reserved.

Printed in USA

AD04(POD)

04/21 (EV-1)

KOMATSU®

All comparisons and claims of improved performance made herein are made with respect to the prior Komatsu model unless otherwise specifically stated.

www.komatsuamerica.com

Product designs, specifications and/or data in this document are provided for informational purposes only and are not warranties of any kind. Product designs and/or specifications may be changed at any time without notice. The only warranties that apply to sales of products and services are Komatsu's standard written warranties, which will be furnished upon request. Komatsu and other trademarks and service marks used herein are the property of Komatsu Ltd. or its subsidiaries, or the respective owners or licensees.

WA480-8